

VON DUPRIN®

98/99 Exit Devices

INDEX

	Introduction	3
Exit Hardware	Rim device.....	4
	Mortise lock device.....	5
	Surface mounted vertical rod device	6
	Concealed vertical rod device	7, 9
	Wood door concealed vertical rod device.....	8
	Three point latch device	10
Fire Exit Hardware	Rim device	12
	Mortise lock device	12
	Surface mounted vertical rod device.....	13
	Concealed vertical rod device	14, 16
	Wood door concealed vertical rod device	15
	Three point latch device	17
Trim Selection	18-21
Device Options	ALK Alarm kit	25
	Braille and embossed touch pads	27
	Breakaway lever trim	21
	Chexit devices.....	27
	CD Cylinder dogging	30
	Double cylinder	27
	E Electric rim device.....	25
	E7500 Electric mortise lock	24
	EL Electric latch retraction	24
	Keypad trim	20
	LX–Latch bolt monitoring	26
	PN Pneumatic latch retraction	27
	RX–Request to exit.....	26
	SS Signal switch	26
Accessories	CDK Cylinder dogging kit.....	30
	HDK Hex key dogging kit.....	30
	Cover plates.....	30
	Cylinders	30
	Dummy push bar.....	30
	Electric power transfer.....	28
	Glass bead kit.....	30
	Power supplies	29
	Vertical rod and latch guard.....	28
Additional Information	ANSI grade, type & function.....	32
	Device dimensions.....	35
	Electrical applications	31
	Finishes	33
	Fire label ratings/applications	32
	Handing	35
	How-To-Order Information.....	35
	Nomenclature	34
	Popular double door applications	31
	Strike application/minimum stile	22, 23

VON DUPRIN®

98/99 Exit Devices

INTRODUCTION

The proper selection and application of exit hardware, in addition to safety, are major concerns to all responsible manufacturers. Exit devices are a critical part of a door opening or egress system and will provide safe and reliable service when properly applied and maintained. It is the policy of Von Duprin Division, Ingersoll-Rand Company, to design and manufacture exit devices to a high standard of quality and reliability in accordance with accepted U.S. domestic and international standards. All 98 and 99 series exit devices are UL listed for Accident Hazard or Fire Exit Hardware, and are tested in accordance to ANSI A156.3, 1994, Grade I.

It is intended that the information included in this publication, when properly used, will provide clear and reliable guidelines to the proper general selection and application. However, the scope of the information is necessarily limited.

Unusual operating conditions and environments and other external influences can affect the proper application of the products represented. Modifications of these products will also affect UL listings. It is recommended that whenever an unusual application condition exists, or when any modification of a product is considered, that our engineers review the application.

Application engineering services are available to help ensure proper selection or to review any areas where users of Von Duprin products may have questions.

Von Duprin push pad exit devices are available in two external surface styles, designated 98 Series and 99 Series.

The two styles are mechanically and dimensionally identical and provide a wide selection of appearance options.

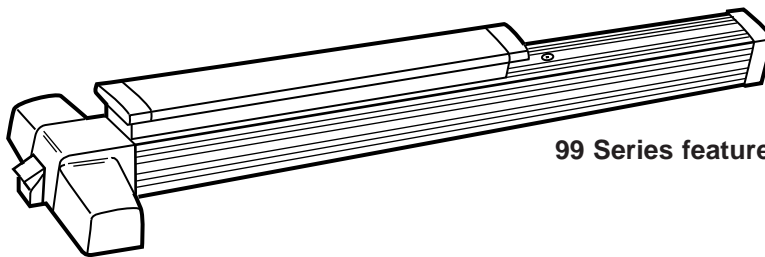

99 Series features grooved mechanism case.

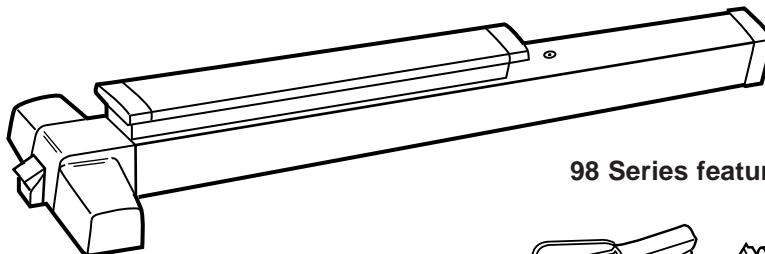

98 Series features smooth mechanism case.

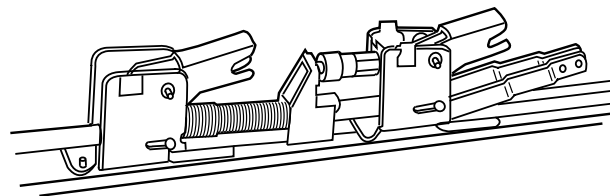

THE QUIET ONE®

A fluid dampener decelerates the push pad on its return stroke and eliminates most noise associated with exit device operations. Furnished on all 98/99 series exit devices.

VON DUPRIN® 98/99 Rim Devices

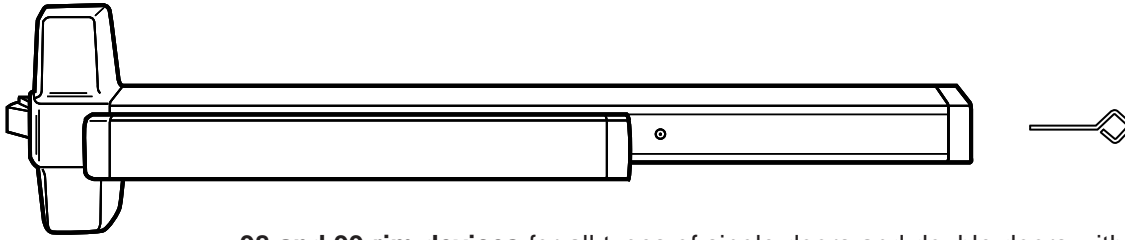

98 and 99 rim devices for all types of single doors and double doors with mullion, UL listed for accident hazard installations. Covers stock hollow metal doors with 86 or 161 cutouts.



299

FEATURES

- Nonhanded
- Field sizeable
- $\frac{3}{4}$ " (19mm) throw, latch bolt
- Latch bolt deadlocking
- Eight popular finishes
- Hex key dogging

DIMENSIONS

Touchbar height to finished floor	$39\frac{13}{16}$ " (935mm) at center
Touchbar projection — neutral	$3\frac{13}{16}$ " (97mm)
depressed	$3\frac{1}{16}$ " (78mm)
Center case	$8" \times 2\frac{1}{4}" \times 2\frac{3}{4}"$ (203mm \times 57mm \times 70mm)
Device length — Short 3'	2'6" to 3' (762mm to 914mm) door size
Long 4'	3'1" to 4' (940mm to 1219mm) door size

OUTSIDE TRIM

Standard

990NL-R/V
990TP-R/V
990DT
110NL-MD
991K-R/V
992L-R/V

Optional

990EO
696NL-R/V
696TP-R/V
696DT
697NL-R/V
697TP-R/V
697DT
KP992L-R/V
994L-R/V
110NL-WD
392-7

For complete outside trim information, see pages 18-19.

STRIKES AND FASTENERS

Device is furnished with standard 299 strike in dull black finish. All necessary fasteners are included. Optional strikes and finishes are available. For strike applications, dimensions, and minimum door stile information refer to pages 22, 23.

A combination of fasteners are included for surface mounting and through bolting to trim on $1\frac{3}{4}$ " (44mm) and $2\frac{1}{4}$ " (57mm) thick doors.

DEVICE OPTIONS

Electric latch retraction, page 24
Pneumatic latch retraction, page 27
Electric rim device, page 25
Request to exit switch, page 26
Latch bolt monitoring, page 26
Signal switch, page 26
Cylinder dogging, page 30
Double cylinder, page 27

For How-To-Order Information on all devices, see page 35.

VON DUPRIN®

98/99 Mortise Lock Devices

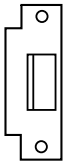
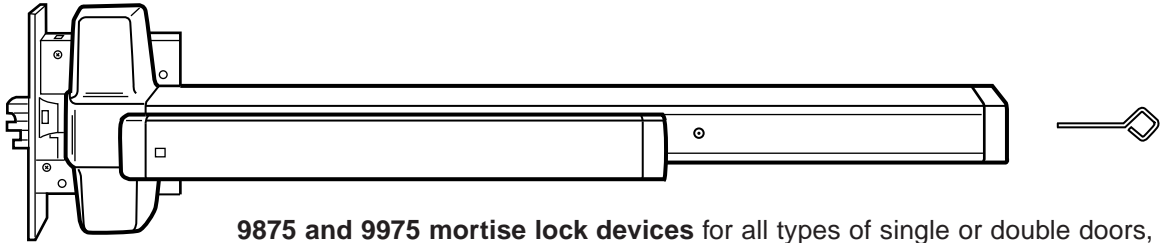

575

9875 and 9975 mortise lock devices for all types of single or double doors, UL listed for accident hazard installations. Fits stock hollow metal doors with 86 cutout and door stiles as narrow as 4³/₄" (1238mm).

The 7500 Mortise lock is equipped with a ³/₄" (19mm) anti-friction latch bolt which is field reversible without removing the lock from the door. It has a nonhanded auxiliary bolt for deadlocking and a faceplate with an adjustable bevel. Field selection of functions are furnished standard. TP, K, or L function may be field selected by adjusting a set screw, refer to pages 24-26.

FEATURES

- Nonhanded
- Full reversible mortise lock
- Field sizeable
- ³/₄" (19mm) throw, anti-friction latch bolt
- Latch bolt deadlocking
- Eight popular finishes
- Hex key dogging

DIMENSIONS

Touchbar height to finished floor	39 ⁵ / ₈ " (1006mm) at center
Latch bolt height to finished floor	40 ³ / ₃₂ " (1018mm) at center
Touchbar projection — neutral	3 ¹³ / ₁₆ " (97mm)
depressed	3 ¹ / ₁₆ " (78mm)
Center case	8" × 2 ¹ / ₄ " × 2 ³ / ₄ " (203mm × 57mm × 70mm)
Device length — Short 3'	2'6" to 3' (762mm to 914mm) door size
Long 4'	3'1" to 4' (940mm to 1219mm) door size
Lock case	4 ⁵ / ₈ " × 5 ³ / ₄ " × 1" (117mm × 146mm × 25mm)
Faceplate	1 ¹ / ₄ " × 8" × ⁷ / ₃₂ " (32mm × 2438mm × 6mm)
Cylinder backset	2 ³ / ₄ " (70mm)

OUTSIDE TRIM

Standard

990NL-M
990TP-M
990DT
991K-M
992L-M

Optional

990EO
696NL-M
696TP-M
696DT
697NL-M
697TP-M
697DT
KP992L-M
994L-M
392-7

For complete outside trim information, see pages 18-19.

STRIKES AND FASTENERS

Device is furnished with standard 575 strike in dull black finish. All necessary fasteners are included. Optional strikes and finishes are available. For strike dimensions refer to pages 22, 23.

A combination of fasteners are included for surface mounting and through bolting to trim on 1³/₄" (44mm) and 2¹/₄" (57mm) thick doors.

DEVICE OPTIONS

Electric latch retraction, page 24
Pneumatic latch retraction, page 27
Electric mortise device, page 24
Request to exit switch, page 26

Latch bolt monitoring, page 26
Signal switch, page 26
Cylinder dogging, page 30

For How-To-Order Information on all devices, see page 35.

VON DUPRIN®

98/99 Surface Mounted Vertical Rod Devices

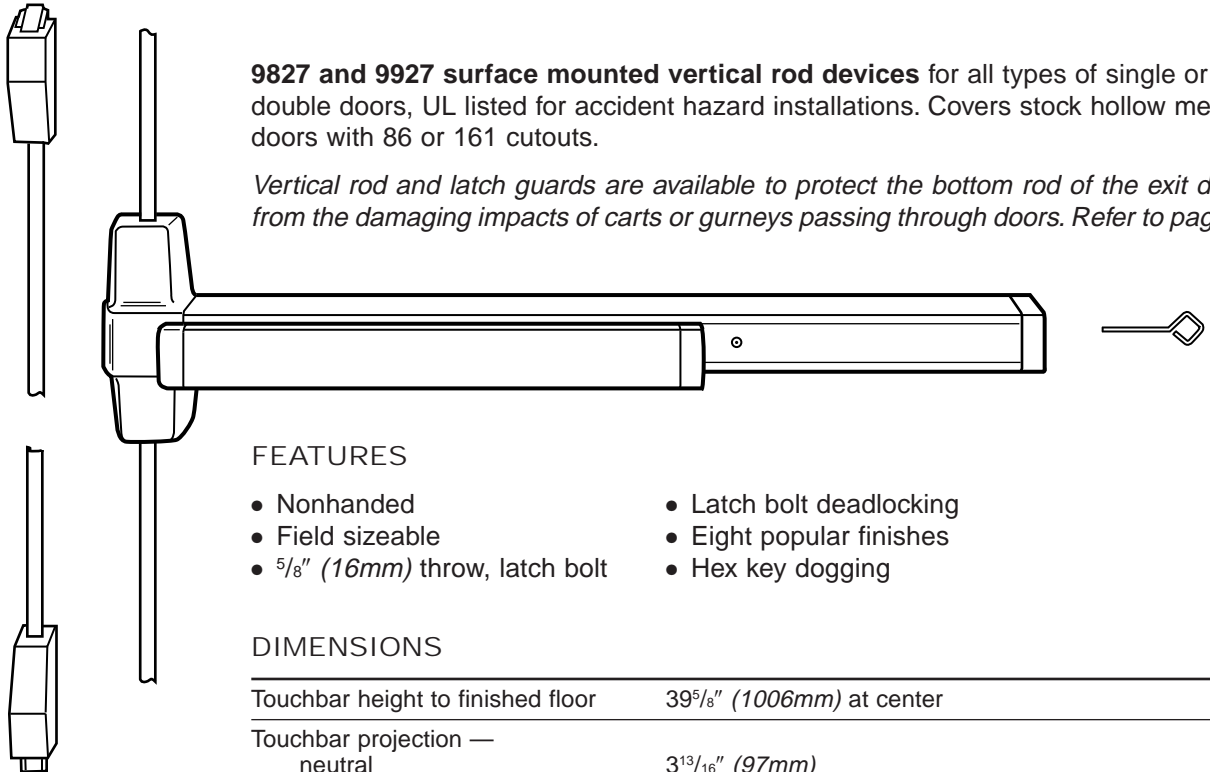

9827 and 9927 surface mounted vertical rod devices for all types of single or double doors, UL listed for accident hazard installations. Covers stock hollow metal doors with 86 or 161 cutouts.

Vertical rod and latch guards are available to protect the bottom rod of the exit device from the damaging impacts of carts or gurneys passing through doors. Refer to page 28.

FEATURES

- Nonhanded
- Field sizeable
- $\frac{5}{8}$ " (16mm) throw, latch bolt
- Latch bolt deadlocking
- Eight popular finishes
- Hex key dogging

DIMENSIONS

Touchbar height to finished floor	39 $\frac{5}{8}$ " (1006mm) at center
Touchbar projection — neutral	3 $\frac{13}{16}$ " (97mm)
depressed	3 $\frac{1}{16}$ " (78mm)
Center case	8" × 2 $\frac{1}{4}$ " × 2 $\frac{3}{4}$ " (203mm × 57mm × 70mm)
Device length — Short 3'	2'6" to 3' (762mm to 914mm) door size
Long 4'	3'1" to 4' (940mm to 1219mm) door size
Top & bottom latch case	4 $\frac{1}{2}$ " × 2 $\frac{1}{8}$ " × 1 $\frac{1}{2}$ " (114mm × 54mm × 38mm)
Vertical rod	$\frac{1}{2}$ " (13mm) square tubing

Note: Maximum door undercut, $\frac{1}{4}$ " (6mm).

STRIKES AND FASTENERS

Device is furnished with standard 299, 248L, and 304L strikes. All necessary fasteners are included. Optional strikes and finishes are available. For strike applications, dimensions, and minimum door stile information refer to pages 22, 23.

A combination of fasteners are included for surface mounting and through bolting to trim on 1 $\frac{3}{4}$ " (44mm) and 2 $\frac{1}{4}$ " (57mm) thick doors. Sex nuts and bolts required for mounting latches are furnished standard.

DEVICE OPTIONS

- Electric latch retraction, page 24
- Pneumatic latch retraction, page 27
- Request to exit switch, page 26
- Latch bolt monitoring, page 26
- Signal switch, page 26
- Cylinder dogging, page 30

For How-To-Order Information on all devices, see page 35.

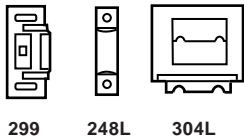

299 248L 304L

OUTSIDE TRIM

Standard

- 990NL-R/V
- 990TP-R/V
- 990DT
- 991K-R/V
- 992L-R/V
- 374T × 990DT
- 110NL-MD

Optional

- 696NL-R/V
- 696TP-R/V
- 696DT
- 697NL-R/V
- 697TP-R/V
- 697DT
- KP992L-R/V
- 994L-R/V
- 392-7
- 110NL-WD

For complete outside trim information, see pages 18-19.

VON DUPRIN®

98/99 Concealed Vertical Rod Devices

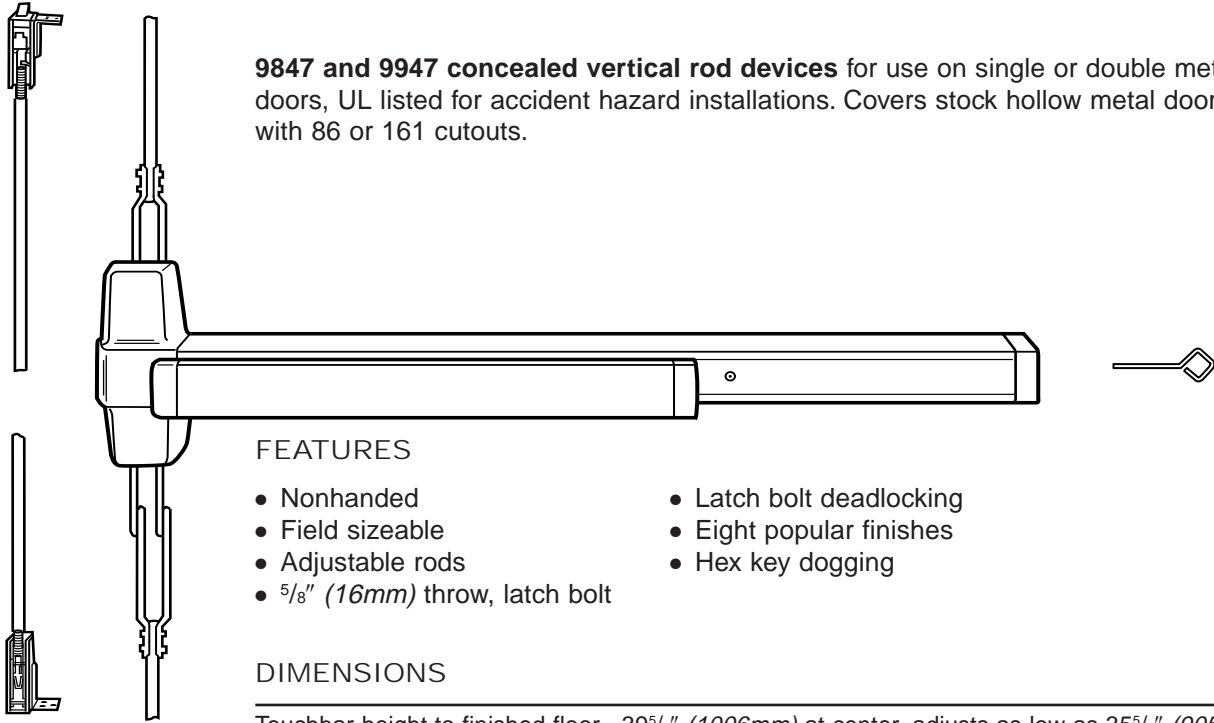

9847 and 9947 concealed vertical rod devices for use on single or double metal doors, UL listed for accident hazard installations. Covers stock hollow metal doors with 86 or 161 cutouts.

FEATURES

- Nonhanded
- Field sizeable
- Adjustable rods
- $\frac{5}{8}$ " (16mm) throw, latch bolt
- Latch bolt deadlocking
- Eight popular finishes
- Hex key dogging

DIMENSIONS

Touchbar height to finished floor	39 $\frac{5}{8}$ " (1006mm) at center, adjusts as low as 35 $\frac{5}{8}$ " (905mm)
Touchbar projection —	
neutral	3 $\frac{13}{16}$ " (97mm)
depressed	3 $\frac{1}{16}$ " (78mm)
Center case	8" × 2 $\frac{1}{4}$ " × 2 $\frac{3}{4}$ " (203mm × 57mm × 70mm)
Device length —	
Short 3'	2'6" to 3' (762mm to 914mm) door size
Long 4'	3'1" to 4' (940mm to 1219mm) door size
Vertical rods — round	Two piece adjustable rods, doors 6'8" (2027mm) to 8'4" (2533mm)

Note: Maximum door undercut, $\frac{1}{4}$ " (6mm).

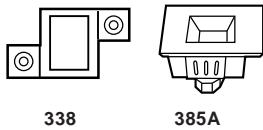

338

385A

OUTSIDE TRIM

Standard

990NL-R/V
990TP-R/V
990DT
991K-R/V
992L-R/V
376T × DT

Optional

696NL-R/V
696TP-R/V
696DT
697NL-R/V
697TP-R/V
697DT
KP992L-R/V
994L-ConcV
392-7

For complete outside trim information, see pages 18-19.

STRIKES AND FASTENERS

Device is furnished with standard 338 and 385A strikes. All necessary fasteners are included. Optional strikes are available. For strike applications, dimensions, and minimum door stile information refer to pages 22, 23.

A combination of fasteners are included for surface mounting and through bolting to trim on 1 $\frac{3}{4}$ " (44mm) and 2 $\frac{1}{4}$ " (57mm) thick doors.

DEVICE OPTIONS

Electric latch retraction, page 24
Pneumatic latch retraction, page 27
Request to exit switch, page 26
Latch bolt monitoring, page 26
Signal switch, page 26
Cylinder dogging, page 30

For How-To-Order Information on all devices, see page 35.

VON DUPRIN®

98/99 Wood Door Concealed Vertical Rod Devices



9847WDC and 9947WDC concealed vertical rod devices for use on single or double wood doors, UL listed for accident hazard installations.

SCALP PLATE

Device is furnished standard with an 8" (203mm) long scalp plate for easy access to rods.

Note: Do not use on pair of doors with 9975.

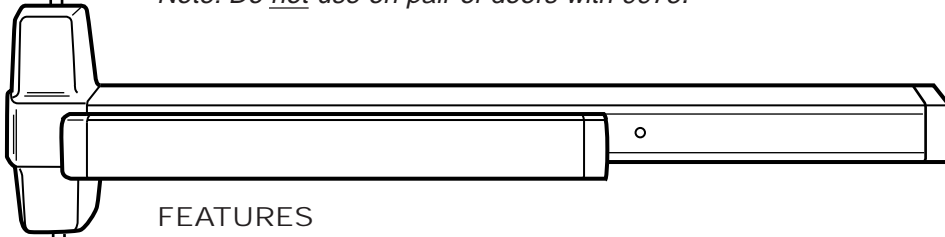

FEATURES

- Nonhanded
- Field sizeable
- Adjustable rods
- $\frac{5}{8}$ " (16mm) throw, latch bolt
- Latch bolt deadlocking
- Eight popular finishes
- Hex key dogging

DIMENSIONS

Touchbar height to finished floor	39 $\frac{13}{16}$ " (1011mm) at center, adjusts as low as 35 $\frac{5}{8}$ " (905mm)
Touchbar projection — neutral	3 $\frac{13}{16}$ " (97mm)
depressed	3 $\frac{1}{16}$ " (78mm)
Center case	8" × 2 $\frac{1}{4}$ " × 2 $\frac{3}{4}$ " (203mm × 57mm × 70mm)
Device length — Short 3'	2'6" to 3' (762mm to 914mm) door size
Long 4'	3'1" to 4' (940mm to 1219mm) door size
Vertical rods — round	Two piece adjustable rods, doors 6'8" (2027mm) to 8'4" (2533mm)

Note: Maximum door undercut, $\frac{1}{4}$ " (6mm).

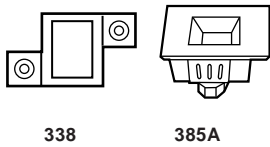

338

385A

OUTSIDE TRIM

Standard

- 990NL-R/V
- 990TP-R/V
- 990DT
- 991K-R/V
- 992L-R/V
- 376T-WDC × 990DT

Optional

- 696NL-R/V
- 696TP-R/V
- 696DT
- 697NL-R/V
- 697TP-R/V
- 697DT
- KP992L-R/V
- 994L-R/V
- 392-7

For complete outside trim information, see pages 18-19.

STRIKES AND FASTENERS

Device is furnished with standard 338 and 385A strikes. All necessary fasteners are included. For strike applications, dimensions, and minimum door stile information refer to pages 22, 23.

A combination of fasteners are included for surface mounting and through bolting to trim on 1 $\frac{3}{4}$ " (44mm) and 2 $\frac{1}{4}$ " (57mm) thick doors. Sex nuts and bolts are furnished standard for mounting.

Note: A door edging will be required, supplied by others.

DEVICE OPTIONS

- Electric latch retraction, page 24
- Pneumatic latch retraction, page 27
- Request to exit switch, page 26
- Latch bolt monitoring, page 26
- Signal switch, page 26
- Cylinder dogging, page 30

For How-To-Order Information on all devices, see page 35.

VON DUPRIN®

98/99 Concealed Vertical Rod Devices

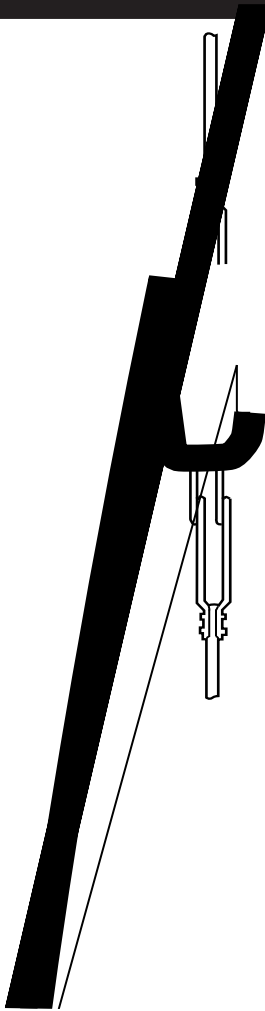

9848 and 9948 concealed vertical rod devices for use on single or double metal doors, UL listed for accident hazard installations. Covers stock hollow metal doors with 86 or 161 cutouts.

FEATURES

- Nonhanded
- Field sizeable
- Adjustable rods
- $\frac{3}{4}$ " (19mm) throw, top latch bolt
- Latch bolt deadlocking
- Eight popular finishes
- Hex key dogging
- $1\frac{1}{2}$ " (38mm) throw, bottom latch bolt

DIMENSIONS

Touchbar height to finished floor	$39\frac{5}{8}$ " (1006mm) at center, adjusts as low as $35\frac{5}{8}$ " (905mm)
Touchbar projection —	
neutral	$3\frac{13}{16}$ " (97mm)
depressed	$3\frac{1}{16}$ " (78mm)
Center case	$8" \times 2\frac{1}{4}" \times 2\frac{3}{4}"$ (203mm \times 57mm \times 70mm)
Device length — Short 3'	2'6" to 3' (762mm to 914mm) door size
Long 4'	3'1" to 4' (940mm to 1219mm) door size
Vertical rods — round	Two piece adjustable rods, doors 6'8" (2027mm) to 8'4" (2533mm)

Note: Maximum door undercut, $\frac{3}{4}$ " (19mm).

OUTSIDE TRIM

Standard

990NL-R/V
990TP-R/V
990DT
991K-R/V
992L-R/V
376T \times DT

Optional

696NL-R/V
696TP-R/V
696DT
697NL-R/V
697TP-R/V
697DT
KP992L-R/V
994L-ConcV
392-7

For complete outside trim information, see pages 18-19.

STRIKES AND FASTENERS

Device is furnished with standard 338 and 385A strikes. All necessary fasteners are included. Optional strikes are available. For strike applications, dimensions, and minimum door stile information refer to pages 22, 23.

A combination of fasteners are included for surface mounting and through bolting to trim on $1\frac{3}{4}$ " (44mm) and $2\frac{1}{4}$ " (57mm) thick doors.

DEVICE OPTIONS

Electric latch retraction, page 24
Pneumatic latch retraction, page 27
Request to exit switch, page 26
Latch bolt monitoring, page 26
Signal switch, page 26
Cylinder dogging, page 30

For How-To-Order Information on all devices, see page 35.

VON DUPRIN® 98/99 Three-Point Latching Devices



9857 and 9957 three-point latching devices for all types of single or double doors with mullion, UL listed for accident hazard installations. Covers stock hollow metal doors with 86 or 161 cutouts.

Vertical rod and latch guards are available to protect the bottom rod of the exit device from the damaging impacts of carts or gurneys passing through doors. Refer to page 28.

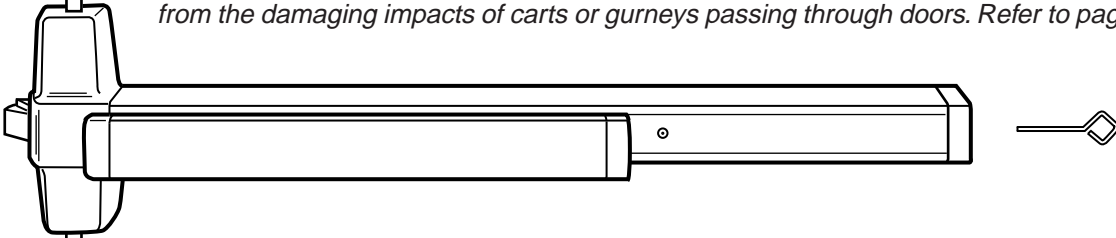

FEATURES

- Nonhanded
- Field sizeable
- $\frac{5}{8}$ " (16mm) throw, latch bolt
- Latch bolt deadlocking
- Eight popular finishes
- Hex key dogging

DIMENSIONS

Touchbar height to finished floor	39 $\frac{5}{8}$ " (1006mm) at center
Touchbar projection — neutral	3 $\frac{13}{16}$ " (97mm)
depressed	3 $\frac{1}{16}$ " (78mm)
Center case	8" × 2 $\frac{1}{4}$ " × 2 $\frac{3}{4}$ " (203mm × 57mm × 70mm)
Device length — Short 3'	2'6" to 3' (762mm to 914mm) door size
Long 4'	3'1" to 4' (940mm to 1219mm) door size
Top & bottom latch case	4 $\frac{1}{2}$ " × 2 $\frac{1}{8}$ " × 1 $\frac{1}{2}$ " (114mm × 54mm × 38mm)
Vertical rod	$\frac{1}{2}$ " (13mm) square tubing

Note: Maximum door undercut, $\frac{1}{4}$ " (6mm).

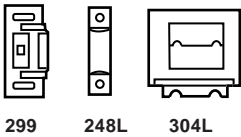

299 248L 304L

OUTSIDE TRIM

Standard

990TP-R/V
990DT
991K-R/V
992L-R/V

Optional

696TP-R/V
696DT
697NL-R/V
697DT
KP992L-R/V
994L-R/V
392-7

For complete outside trim information, see pages 18-19.

STRIKES AND FASTENERS

Device is furnished with standard 299 (two), 248L, and 304L strikes. All necessary fasteners are included. Optional strikes and finishes are available. For strike applications, dimensions, and minimum door stile information refer to pages 22, 23.

A combination of fasteners are included for surface mounting and through bolting to trim on $1\frac{3}{4}$ " (44mm) and $2\frac{1}{4}$ " (57mm) thick doors. Sex nuts and bolts required for mounting latches are furnished standard.

DEVICE OPTIONS

Electric latch retraction, page 24
Pneumatic latch retraction, page 27
Request to exit switch, page 26
Latch bolt monitoring, page 26
Signal switch, page 26
Cylinder dogging, page 30

For How-To-Order Information on all devices, see page 35.

VON DUPRIN®

98/99 Fire Exit Rim Devices



98-F and 99-F fire exit rim devices for all types of 4' × 8' (1219mm × 2438mm) single doors or 8' × 8' (2438mm × 2438mm) double doors with 9954 or 9854 mullion, UL listed for fire exit hardware, 3 hour rating.

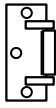

299F

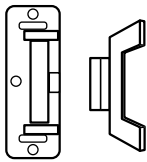

499F

FEATURES

- Nonhanded
- Field sizeable
- $\frac{3}{4}$ " (19mm) throw, latch bolt
- Latch bolt deadlocking
- Eight popular finishes

DIMENSIONS

Touchbar height to finished floor	39 ¹³ / ₁₆ " (935mm) at center
Touchbar projection —	
neutral	3 ¹³ / ₁₆ " (97mm)
depressed	3 ¹ / ₁₆ " (78mm)
Center case	8" × 2 ¹ / ₄ " × 2 ³ / ₄ " (203mm × 57mm × 70mm)
Device length — Short 3'	2'6" to 3' (762mm to 914mm) door size
Long 4'	3'1" to 4' (940mm to 1219mm) door size

STRIKES AND FASTENERS

Device is furnished with standard 299F strike in dull black finish (optional finishes are available) for single door applications. All necessary fasteners are included. Optional 499F strike is **required** on double doors. For strike applications, dimensions, and minimum door stile information refer to pages 22, 23.

A combination of fasteners are included for surface mounting and through bolting to trim on $\frac{1}{4}$ " (44mm) and $\frac{1}{2}$ " (57mm) thick doors.

DEVICE OPTIONS

- Electric latch retraction, page 24
- Pneumatic latch retraction, page 27
- Electric rim device, page 25
- Request to exit switch, page 26
- Latch bolt monitoring, page 26
- Signal switch, page 26
- Double cylinder, page 27

OUTSIDE TRIM

Standard

990NL-R/V
990TP-R/V
110NL-MD
991K-R/V
992L-R/V

Optional

990EO
696NL-R/V
696TP-R/V
697NL-R/V
697TP-R/V
KP992L-R/V
994L-R/V
110NL-WD

For complete outside trim information, see pages 18-19.

For How-To-Order Information on all devices, see page 35.

VON DUPRIN®

98/99 Fire Exit Mortise Lock Devices

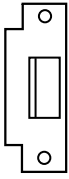
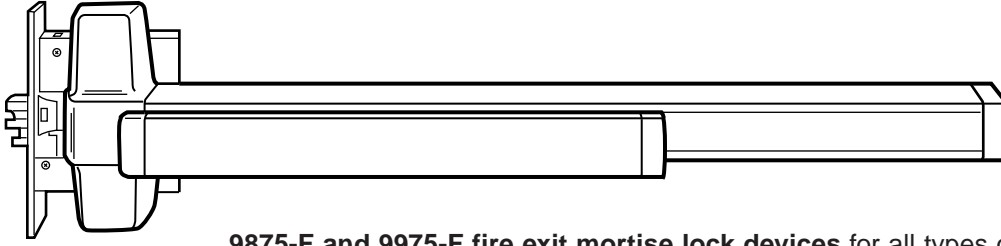

575

9875-F and 9975-F fire exit mortise lock devices for all types of 4' × 10' (1219mm × 3048mm) single or 8' × 10' (2438mm × 3048mm) double door installations, UL listed for fire exit hardware, 3 hours. Fits door stiles as narrow as 4³/₄" (121mm).

The 7500 Mortise lock is equipped with a ³/₄" (19mm) anti-friction latch bolt which is field reversible without removing the lock from the door. It has a nonhanded auxiliary bolt for deadlocking and a faceplate with an adjustable bevel. Field selection of functions are furnished standard. TP, K, or L function may be field selected by adjusting a set screw.

FEATURES

- Nonhanded
- Full reversible mortise lock
- Field sizeable
- ³/₄" (19mm) throw, anti-friction latch bolt
- Latch bolt deadlocking
- Eight popular finishes

DIMENSIONS

Touchbar height to finished floor	39 ⁵ / ₈ " (1006mm) at center
Latch bolt height to finished floor	40 ³ / ₃₂ " (1018mm) at center
Touchbar projection — neutral	3 ¹³ / ₁₆ " (97mm)
depressed	3 ¹ / ₁₆ " (78mm)
Center case	8" × 2 ¹ / ₄ " × 2 ³ / ₄ " (203mm × 57mm × 70mm)
Device length — Short 3'	2'6" to 3' (762mm to 914mm) door size
Long 4'	3'1" to 4' (940mm to 1219mm) door size
Lock case	4 ⁵ / ₈ " × 5 ³ / ₄ " × 1" (117mm × 146mm × 25mm)
Faceplate	1 ¹ / ₄ " × 8" × ⁷ / ₃₂ " (32mm × 2438mm × 6mm)
Cylinder backset	2 ³ / ₄ " (70mm)

OUTSIDE TRIM

Standard

990NL-M
990TP-M
991K-R/V
992L-M

Optional

696NL-M
696TP-M
697NL-M
697TP-M
KP992L-M
994L-M

For complete outside trim information, see pages 18-19.

STRIKES AND FASTENERS

Device is furnished with standard 575 strike in dull black finish. All necessary fasteners are included. Optional strikes and finishes are available. For strike dimensions refer to pages 22, 23.

A combination of fasteners are included for surface mounting and through bolting to trim on 1³/₄" (44mm) and 2¹/₄" (57mm) thick doors.

DEVICE OPTIONS

Electric latch retraction, page 24	Request to exit switch, page 26
Pneumatic latch retraction, page 27	Latch bolt monitoring, page 26
Electric mortise lock, page 24	Signal switch, page 26

For How-To-Order Information on all devices, see page 35.

VON DUPRIN®

98/99 Fire Exit Surface Mounted Vertical Rod Devices



9827-F and 9927-F fire exit surface mounted vertical rod devices for all types of 8' × 8' (2438mm × 2438mm) double doors, UL listed fire exit hardware, 3 hours.

Less Bottom Rod – LBR

LBR option is available, using a spring loaded auxiliary latch bolt installed in the lower door edge. When exposed to heat the auxiliary latch bolt releases, keeping the doors in alignment and closed during a fire. UL listed 3 hours on hollow metal doors double egress, 90 minute swinging same direction, and 20 minutes wood doors.

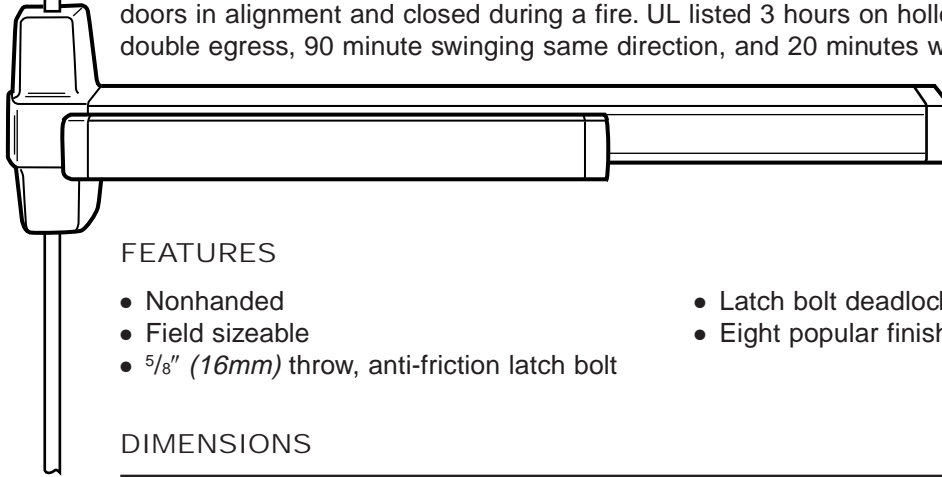

FEATURES

- Nonhanded
- Field sizeable
- $\frac{5}{8}$ " (16mm) throw, anti-friction latch bolt
- Latch bolt deadlocking
- Eight popular finishes

DIMENSIONS

Touchbar height to finished floor	39 $\frac{5}{8}$ " (1006mm) at center
Touchbar projection — neutral	3 $\frac{13}{16}$ " (97mm)
depressed	3 $\frac{1}{16}$ " (78mm)
Center case	8" × 2 $\frac{1}{4}$ " × 2 $\frac{3}{4}$ " (203mm × 57mm × 70mm)
Device length — Short 3'	2'6" to 3' (762mm to 914mm) door size
Long 4'	3'1" to 4' (940mm to 1219mm) door size
Top & bottom latch case	4 $\frac{1}{2}$ " × 2 $\frac{1}{8}$ " × 1 $\frac{1}{2}$ " (114mm × 54mm × 38mm)
Vertical rod	$\frac{1}{2}$ " (13mm) square tubing

Note: Maximum door undercut, $\frac{1}{4}$ " (6mm).

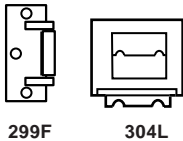

299F

304L

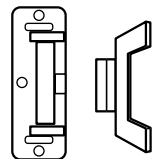

499F

Use with LBR option

STRIKES AND FASTENERS

Device is furnished with standard 299F and 304L strikes. All necessary fasteners are included. Optional strikes and finishes are available. For strike applications, dimensions, and minimum door stile information refer to pages 22, 23.

A combination of fasteners are included for surface mounting and through bolting to trim on 1 $\frac{3}{4}$ " (44mm) and 2 $\frac{1}{4}$ " (57mm) thick doors. Sex nuts and bolts required for mounting latches are furnished standard.

DEVICE OPTIONS

- Electric latch retraction, page 24
- Pneumatic latch retraction, page 27
- Request to exit switch, page 26
- Latch bolt monitoring, page 26
- Signal switch, page 26

Vertical rod and latch guards are available to protect the bottom rod of the exit device from the damaging impacts of carts or gurneys passing through doors. Refer to page 28.

For How-To-Order Information on all devices, see page 35.

OUTSIDE TRIM

Standard

- 990TP-R/V
- 991K-R/V
- 992L-R/V
- 374T × 990DT

Optional

- 696TP-R/V
- 697TP-R/V
- KP992L-R/V
- 994L-R/V

For complete outside trim information, see pages 18-19.

VON DUPRIN®

98/99 Fire Exit Concealed Vertical Rod Devices

9847-F and 9947-F fire exit concealed vertical rod devices for use on 8' × 8' (2438mm × 2438mm) double metal doors, UL listed fire exit hardware, 3 hours.

Less Bottom Rod – LBR

LBR option is available, using a spring loaded auxiliary latch bolt installed in the lower door edge. When exposed to heat the auxiliary latch bolt releases, keeping the doors in alignment and closed during a fire. UL listed 3 hours on double egress doors and 90 minute doors swinging same direction.

FEATURES

- Nonhanded
- Field sizeable
- Adjustable rods
- 5/8" (16mm) throw, latch bolt
- Latch bolt deadlocking
- Eight popular finishes

DIMENSIONS

Touchbar height to finished floor	39 ⁵ / ₈ " (1006mm) at center, adjust as low as 35 ⁵ / ₈ " (905mm)
Touchbar projection —	
neutral	3 ¹³ / ₁₆ " (97mm)
depressed	3 ¹ / ₁₆ " (78mm)
Center case	8" × 2 ¹ / ₄ " × 2 ³ / ₄ " (203mm × 57mm × 70mm)
Device length — Short 3'	2'6" to 3' (762mm to 914mm) door size
Long 4'	3'1" to 4' (940mm to 1219mm) door size
Vertical rods — round	Two piece adjustable rods, door 6'8" (2027mm) to 8'4" (2533mm)

Note: Maximum door undercut, 1/4" (6mm).

STRIKES AND FASTENERS

Device is furnished with standard 338 and 385A strikes. All necessary fasteners are included. Optional strikes are available. For strike applications, dimensions, and minimum door stile information refer to pages 22, 23.

A combination of fasteners are included for surface mounting and through bolting to trim on 1³/₄" (44mm) and 2¹/₄" (57mm) thick doors.

DEVICE OPTIONS

- Electric latch retraction, page 24
- Pneumatic latch retraction, page 27
- Request to exit switch, page 26
- Latch bolt monitoring, page 26
- Signal switch, page 26

OUTSIDE TRIM

Standard

990NL-R/V
990TP-R/V
991K-R/V
992L-R/V
376T × 990DT

Optional

696NL-R/V
696TP-R/V
697NL-R/V
697TP-R/V
994L-ConcV

For complete outside trim information, see pages 18-19.

For How-To-Order Information on all devices, see page 35.

VON DUPRIN®

98/99 Fire Exit Wood Concealed Vertical Rod Devices

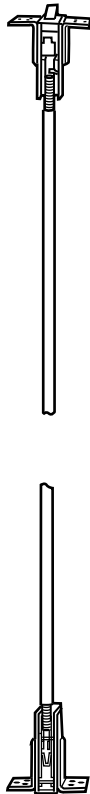

9847WDC-F and 9947WDC-F concealed vertical rod devices for use on single or double wood doors, UL listed fire exit hardware, 90 minute installations, 8' × 9'3" (2438mm × 2819mm).

Less Bottom Rod – LBR

LBR option is available, using a spring loaded auxiliary latch bolt installed in the lower door edge. When exposed to heat the auxiliary latch bolt releases, keeping the doors in alignment and closed during a fire. UL listed 20 minute doors.

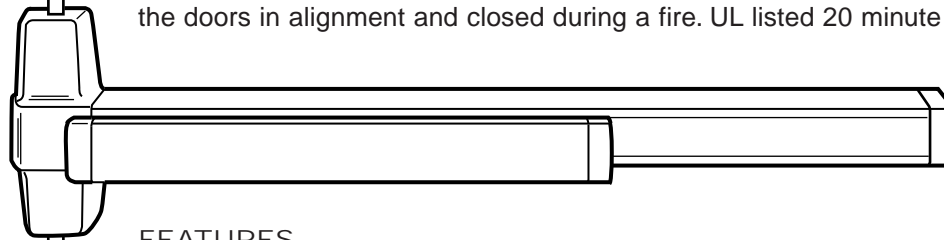

FEATURES

- Nonhanded
- Field sizeable
- Adjustable rods
- 5/8" (16mm) throw, latch bolt
- Latch bolt deadlocking
- Eight popular finishes

DIMENSIONS

Touchbar height to finished floor	39 ¹³ / ₁₆ " (1011mm) at center, adjust as low as 35 ⁵ / ₈ " (905mm)
Touchbar projection — neutral	3 ¹³ / ₁₆ " (97mm)
depressed	3 ¹ / ₁₆ " (78mm)
Center case	8" × 2 ¹ / ₄ " × 2 ³ / ₄ " (203mm × 57mm × 70mm)
Device length — Short 3'	2'6" to 3' (762mm to 914mm) door size
Long 4'	3'1" to 4' (940mm to 1219mm) door size
Vertical rods — round	Two piece adjustable rods, door 6'8" (2027mm) to 8'4" (2533mm)

Note: Maximum door undercut, 1/4" (6mm).

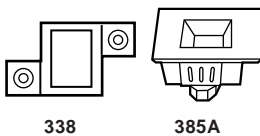

338

385A

STRIKES AND FASTENERS

Device is furnished with standard 338 and 385A strikes. All necessary fasteners are included. For strike applications, dimensions, and minimum door stile information refer to pages 22, 23.

A combination of fasteners are included for surface mounting and through bolting to trim on 1³/₄" (44mm) and 2¹/₄" (57mm) thick doors. Sex nuts and bolts are furnished standard for mounting.

OUTSIDE TRIM

Standard

990NL-R/V
990TP-R/V
991K-R/V
992L-R/V
376T-WDC × 990DT

Optional

696NL-R/V
696TP-R/V
697NL-R/V
697TP-R/V
994L-ConcV

For complete outside trim information, see pages 18-19.

SCALP PLATE

Device is furnished standard with an 8" (203mm) long scalp plate for easy access to rods. A door edging will be required by others.

Note: Do not use on pair of doors with 9975-F.

DEVICE OPTIONS

Electric latch retraction, page 24	Latch bolt monitoring, page 26
Pneumatic latch retraction, page 27	Signal switch, page 26
Request to exit switch, page 26	Cylinder dogging, page 30

For How-To-Order Information on all devices, see page 35.

VON DUPRIN® 98/99 Fire Exit Concealed Vertical Rod Devices

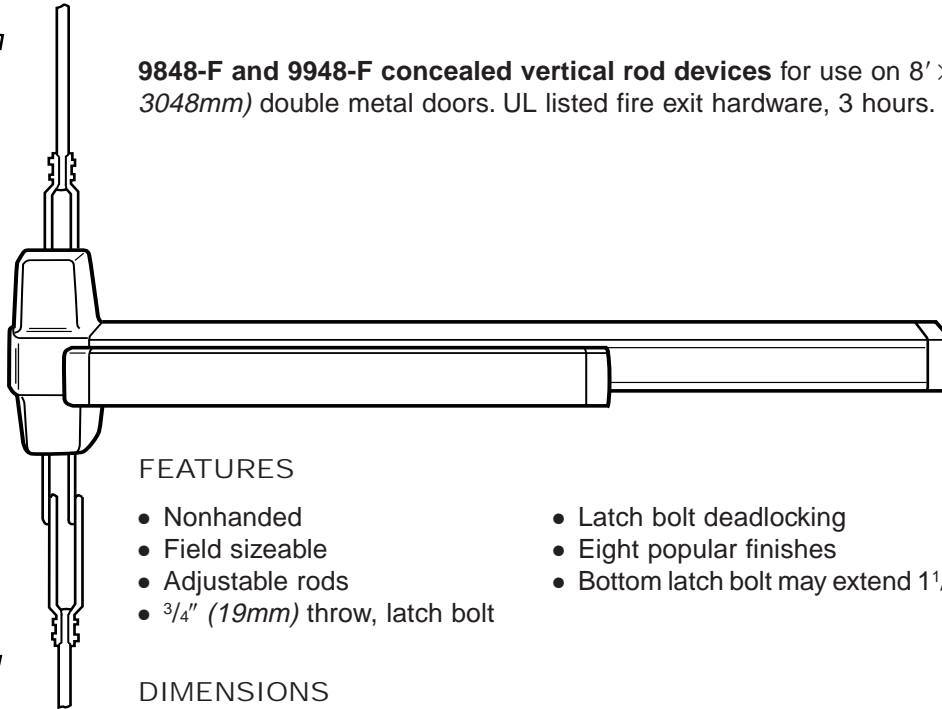
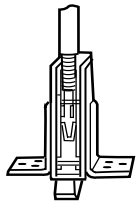
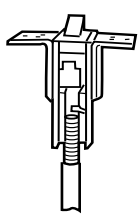

9848-F and 9948-F concealed vertical rod devices for use on 8' × 10' (2438mm × 3048mm) double metal doors. UL listed fire exit hardware, 3 hours.

FEATURES

- Nonhanded
- Field sizeable
- Adjustable rods
- $\frac{3}{4}$ " (19mm) throw, latch bolt
- Latch bolt deadlocking
- Eight popular finishes
- Bottom latch bolt may extend $1\frac{1}{2}$ " (38mm)

DIMENSIONS

Touchbar height to finished floor	39 $\frac{5}{8}$ " (1006mm) at center, adjust as low as 35 $\frac{5}{8}$ " (905mm)
Touchbar projection — neutral	3 $\frac{13}{16}$ " (97mm)
depressed	3 $\frac{1}{16}$ " (78mm)
Center case	8" × 2 $\frac{1}{4}$ " × 2 $\frac{3}{4}$ " (203mm × 57mm × 70mm)
Device length — Short 3'	2'6" to 3' (762mm to 914mm) door size
Long 4'	3'1" to 4' (940mm to 1219mm) door size
Vertical rods — round	Two piece adjustable rods, doors 6'8" (2027mm) to 8'4" (2533mm)

Note: Maximum door undercut, $\frac{3}{4}$ " (19mm).

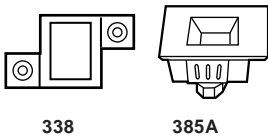

338

385A

STRIKES AND FASTENERS

Device is furnished with standard 338 and 385A strikes. All necessary fasteners are included. Optional strikes are available. For strike applications, dimensions, and minimum door stile information refer to pages 22, 23.

A combination of fasteners are included for surface mounting and through bolting to trim on $1\frac{3}{4}$ " (44mm) and 2 $\frac{1}{4}$ " (57mm) thick doors.

DEVICE OPTIONS

- Electric latch retraction, page 24
- Pneumatic latch retraction, page 27
- Request to exit switch, page 26
- Latch bolt monitoring, page 26
- Signal switch, page 26

OUTSIDE TRIM

Standard

990NL-R/V
990TP-R/V
991K-R/V
992L-R/V
376T × 990DT

Optional

696NL-R/V
696TP-R/V
697NL-R/V
697TP-R/V
994L-ConcV

For complete outside trim information, see pages 18-19.

For How-To-Order Information on all devices, see page 35.

VON DUPRIN®

98/99 Three-Point Latching Devices

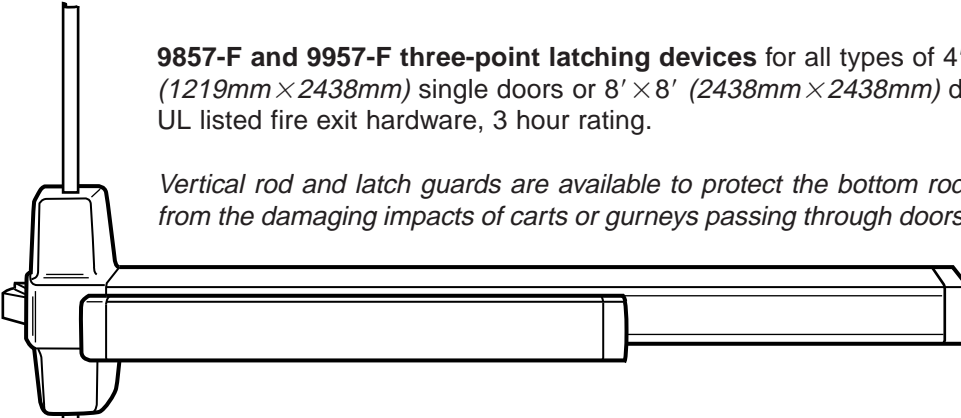

9857-F and 9957-F three-point latching devices for all types of 4' × 8' (1219mm × 2438mm) single doors or 8' × 8' (2438mm × 2438mm) double doors. UL listed fire exit hardware, 3 hour rating.

Vertical rod and latch guards are available to protect the bottom rod of the exit device from the damaging impacts of carts or gurneys passing through doors. Refer to page 28.

FEATURES

- Nonhanded
- Field sizeable
- $\frac{5}{8}$ " (16mm) throw, latch bolt
- Latch bolt deadlocking
- Eight popular finishes

DIMENSIONS

Touchbar height to finished floor	39 $\frac{5}{8}$ " (1006mm) at center
Touchbar projection — neutral	3 $\frac{13}{16}$ " (97mm)
depressed	3 $\frac{1}{16}$ " (78mm)
Center case	8" × 2 $\frac{1}{4}$ " × 2 $\frac{3}{4}$ " (203mm × 57mm × 70mm)
Device length — Short 3'	2'6" to 3' (762mm to 914mm) door size
Long 4'	3'1" to 4' (940mm to 1219mm) door size
Top & bottom latch case	4 $\frac{1}{2}$ " × 2 $\frac{1}{8}$ " × 1 $\frac{1}{2}$ " (114mm × 54mm × 38mm)
Vertical rod	$\frac{1}{2}$ " (13mm) square tubing

Note: Maximum door undercut, $\frac{1}{4}$ " (6mm).

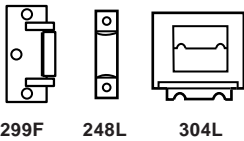

299F 248L 304L

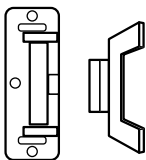

499F

Use on pairs of doors with 9954 mullion.

OUTSIDE TRIM

Standard

990TP-R/V
991K-R/V
992L-R/V

Optional

696NL-R/V
696TP-R/V
697TP-R/V
KP992L-R/V
994L-R/V

For complete outside trim information, see pages 18-19.

STRIKES AND FASTENERS

Device is furnished with standard 299F (two), 248L, and 304L strikes. All necessary fasteners are included. Optional strikes and finishes are available. For strike applications, dimensions, and minimum door stile information refer to pages 22, 23.

A combination of fasteners are included for surface mounting and through bolting to trim on $1\frac{3}{4}$ " (44mm) and $2\frac{1}{4}$ " (57mm) thick doors. Sex nuts and bolts required for mounting latches are furnished standard.



DEVICE OPTIONS

Electric latch retraction, page 24
Pneumatic latch retraction, page 27
Request to exit switch, page 26
Latch bolt monitoring, page 26
Signal switch, page 26

For How-To-Order Information on all devices, see page 35.

VON DUPRIN®

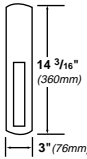
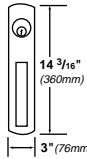
98/99 Trim Selection

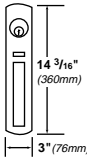
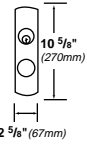
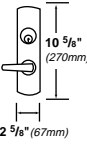
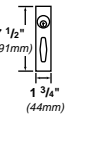
Function	01 Exit Only	02 Pull When Dogged	03 Key Retracts Latch Bolt	03 Key Retracts Latch Bolt	05 Key Locks Thumbpiece	08* Key Locks Knob	08* Key Locks Lever	11 Key Locks Thumbturn	
Trim Number and Dimensions		990DT 	990NL 	110NL (Pull Required) 	990TP 	991K 	992L 	374T 	
Device/Trim Center Line To Finished Floor									
Projection	—	2" (51mm)	2" (51mm)	—	2" (51mm)	3 1/4" (95mm)	2 3/4" (70mm)	1 3/4" (44mm)	
Rim	Panic	98EO 99EO	98DT 99DT	98NL 99NL	98NL-OP 99NL-OP	98TP 99TP	98K 99K	98L 99L	—
	Fire	98EO-F 99EO-F	—	98NL-F 99NL-F	98NL-OP-F 99NL-OP-F	98TP-F 99TP-F	98K-F 99K-F	98L-F 99L-F	—
Mortise Lock	Panic	9875EO 9975EO	9875DT 9975DT	9875NL 9975NL	—	9875TP 9975TP	9875K 9975K	9875L 9975L	—
	Fire	9875EO-F 9975EO-F	—	9875NL-F 9975NL-F	—	9875TP-F 9975TP-F	9875K-F 9975K-F	9875L-F 9975L-F	—
Surface Mounted Vertical Rod	Panic	9827EO 9927EO	9827DT 9927DT	9827NL 9927NL	9827NL-OP 9927NL-OP	9827TP 9927TP	9827K 9927K	9827L 9927L	9827TL 9927TL
	Fire	9827EO-F 9927EO-F	—	9827NL-F 9927NL-F	9827NL-OP-F 9927NL-OP-F	9827TP-F 9927TP-F	9827K-F 9927K-F	9827L-F 9927L-F	9827TL-F 9927TL-F
Concealed Vertical Rod	Panic	9847EO 9947EO	9847DT 9947DT	9847NL 9947NL	9847NL-OP 9947NL-OP	9847TP 9947TP	9847K 9947K	9847L 9947L	—
	Fire	9847EO-F 9947EO-F	—	9847NL-F 9947NL-F	9847NL-OP-F 9947NL-OP-F	9847TP-F 9947TP-F	9847K-F 9947K-F	9847L-F 9947L-F	—
Concealed Vertical Rod Wood Door	Panic	9847WDC-EO 9947WDC-EO	9847WDC-DT 9947WDC-DT	9847WDC-NL 9947WDC-NL	9847WDC-NL-OP 9947WDC-NL-OP	9847WDC-TP 9947WDC-TP	9847WDC-K 9947WDC-K	9847WDC-NL 9947WDC-NL	9847WDC-TL 9947WDC-TL
	Fire	9847WDC-EO-F 9947WDC-EO-F	—	9847WDC-NL-F 9947WDC-NL-F	9847WDC-NL-OP-F 9947WDC-NL-OP-F	9847WDC-TP-F 9947WDC-TP-F	9847WDC-K-F 9947WDC-K-F	9847WDC-L 9947WDC-L	—
Three Point Latch	Panic	9857EO 9957EO	9857DT 9957DT	—	—	9857TP 9957TP	9857K 9957K	9857L 9957L	—
	Fire	9857EO-F 9957EO-F	—	—	—	9857TP-F 9957TP-F	9857K-F 9957K-F	9857L-F 9957L-F	—
Additional SNB requirements	6	2	2	6	2	2	2	2	

*Refer to additional lever or knob information, page 19.

VON DUPRIN® 98/99 Trim Selection

STANDARD TRIM

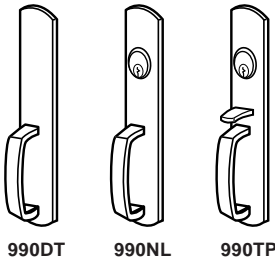

990DT 990NL 990TP

SERIES 990

Heavy 10 gauge (2.4mm) brass, bronze, or stainless steel. Available functions: 990DT, 990NL, and 990TP. Optional 990EO exit only trim plate is available in this series. When ordering with the exit device, use 99EOx990EO.

SERIES 992L and 991K

Lever trim has a forged brass $\frac{3}{4}$ " (19mm) thick escutcheon and is available in three operating options, 992LxDT, 992LxNL, and 992LxBE. Refer to operation options for additional information.

Knob trim has a forged brass $\frac{3}{4}$ " (19mm) thick escutcheon and is available in three operating options, 991KxDT, 991KxNL, and 991KxBE. Refer to operation options for additional information.

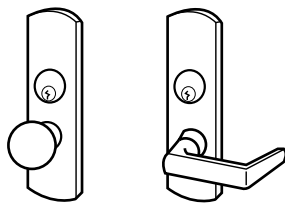

991K 992L

LEVER DESIGN OPTIONS



#01 #02 #03 #06 (Std.) #07 #12 #17

OPERATION OPTIONS — LEVER AND KNOB

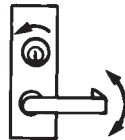

Standard operation, key locks and unlocks lever or knob.



Night latch, key retracts latch bolt. Lever or knob is rigid. Use NL suffix, e.g., 992L-NL.

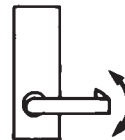

Blank escutcheon, lever or knob always active. Use BE suffix, e.g., 992L-BE.

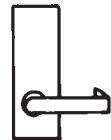

Dummy trim, lever or knob rigid for pull operation. Use DT suffix, e.g., 992L-DT.



370

SERIES 370

Thumbturn control has a forged brass $\frac{7}{8}$ " (22mm) thick escutcheon. Often used with DT trim or pull.

OPTIONAL TRIM

SERIES 696

Narrow design $\frac{3}{16}$ " (5mm) thick brass, bronze, or stainless steel with flat pull grip. Available functions: 696DT, 696NL, and 696TP. When ordering with the exit device, specify trim. Example: 99NLx696NL.

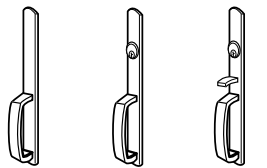

696DT 696NL 696TP

SERIES 697

Narrow design $\frac{3}{16}$ " (5mm) thick brass, bronze, or stainless steel with round pull grip. Available functions: 697DT, 697NL, and 697TP. When ordering with the exit device, specify trim. Example: 99NLx697NL.

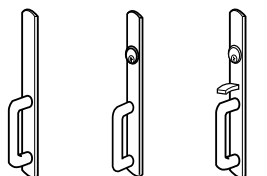

697DT 697NL 697TP

SERIES 392-7

Offset solid brass, bronze, or stainless steel $\frac{3}{4}$ " (19mm) wire pull. Through bolts to exit device.

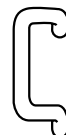

392-7

VON DUPRIN®

98/99 Trim Selection

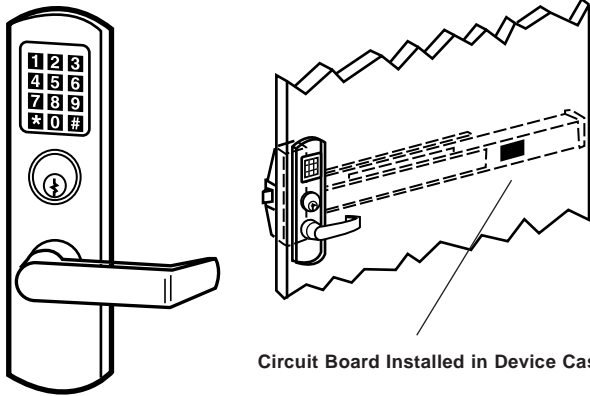

Circuit Board Installed in Device Case

KEYPAD TRIM

Outside trim with built-in keypad for single door applications, easy to install, program and operate. The keypad trim is designed to use, with several Von Duprin electrified exit devices: EL98/EL99 Series electric latch retraction, E9875/E9975 electric mortise lock, and E98/E99 electric rim exit device, panic or fire.

Keypads are available with standard 992L lever trim. Outside options include active or rigid operation, with or without key cylinder for maximum application flexibility.

Features:

- 100 User Codes
- Variable Code Lengths, 2 to 6 Digits
- LED Feedback
- Keypad Lockout on False Entries
- 1 Million Code Combinations
- Weather Resistant
- Maintained/Momentary output
- Field Handing

Operational Details

LED

There are three LED indicator: red, green, and yellow. Red is locked, green is unlocked, and yellow shows programming acknowledgment.

False Entry

When multiple false code entries are made (programmable 3 to 25), the keypad will switch to an inoperative status. The master or supervisor code will override this condition.

Maintained/Momentary Switch

The units are programmable for either maintained or momentary operation. In maintained, a valid code will unlock and remain unlocked. When the code is entered a second time, relocking will occur.

In momentary, a valid code will unlock, but automatic relocking will occur (programmable 1 to 90 seconds).

Weather Resistant

The keypad has been tested and approved for outside operation in temperatures from -5°F (-28°C) to 125°F (50°C). Trim should be protected from direct rain and snow.

Specifications:

- Voltage — 24 VDC @ .15 ampere
- Output — Relay, SPDT 2.0 @ 24 VDC

To order, specify:

1. KP prefix, KP992L.
2. Function option DT (see page 19).
3. Lever style, other than #06 (see page 19).

Valid Combinations

Device	Function			
	L (Std)	L-NL	L-BE	L-DT
E98/99	✓	—	✓	—
EL98/99*	✓	✓	✓	✓
E98/9975	✓	—	✓	—

*Applies to all mounting types.

VON DUPRIN® 98/99 Trim Selection

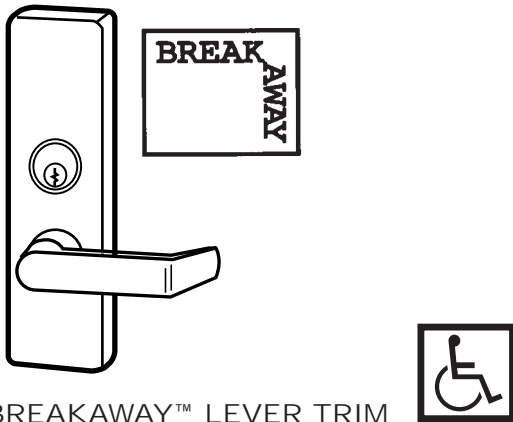

BREAKAWAY™ LEVER TRIM

Breakaway Lever Trim Series 994L will significantly reduce damage from vandalism and abuse, while helping meet ADA-mandated accessibility standards. The patented Breakaway trim is available for Von Duprin Series 98 and 99 exit devices and can be installed on existing 992L lever trim prep for retrofit applications.

Lever trim, mandated on public buildings since January 26, 1992, is vulnerable to vandalism and abuse that can cause the lever or internal trim parts to break, rendering the door inoperable and necessitating costly, recurring repairs. The Breakaway design allows the lever to break away and drop into a “down” position when abused, discouraging further abuse and protecting its internal parts. Further, it can be easily reset to its operating position by a simple uplift motion.

When unlocked, the unit operates as a normal lever trim. When locked, the lever feels locked but when more than 35 pounds of torque are applied, the lever breaks away and travels to a 90-degree down position. To prevent further damage to internal trim parts or to the exit device, an easily replaced shear pin breaks at 65 to 75 pounds of torque.

Series 994L trim features a smooth precise operation and a flip cam design to allow easy handing in the field. Installation or repairs are simple. An embossed cylinder improves aesthetics and security.

The Breakaway design was lab tested to 500,000 cycles in the unlocked position and to 10,000 “break” cycles, after which it still maintained the required 35 pounds torque to break away.

All standard lever designs and function options are available.

To order specify:

1. 994L Trim.
2. Function option, NL, BE, or DT (see page 19).
3. Lever style, other than #06 (see page 19).

Note: Night latch and dummy trims have rigid levers and do not break away.

VON DUPRIN®

98/99 Strike/Stile Information

STRIKE APPLICATION/MINIMUM STILE

Device Type	Standard					Optional						
	Single door		Double door			Single door		Double door				
	Strike	Stile		Strike w/Mullion* Stile		Strike	Stile		Strike w/Mullion* Stile			
		× 990	× 696/697	× 990	× 696/697		× 990	× 696/697	× 990	× 696/697		
98 99	299	4 1/2" (114mm)	4 3/8" (111mm)	299 × 4954	4 7/8" (124mm)	4 3/4" (121mm)	1409	3 13/16" (97mm)	3 13/16" (97mm)	299 × 5254/5654	4 7/16" (113mm)	4 1/4" (108mm)
							1410	3 13/16" (97mm)	3 13/16" (97mm)	299 × 5554/5754	3 13/16" (97mm)	3 13/16" (97mm)
							1606	4 1/16" (103mm)	3 15/16" (100mm)	1606 × 1654	4 7/16" (113mm)	4 1/4" (108mm)
98-F/99-F	299F	4 1/2" (114mm)	4 3/8" (111mm)	499F × 9954	4 7/8" (124mm)	4 3/4" (121mm)	—	—	—	—	—	—
9875 9975	575	4 3/4" (121mm)		—	—	—	—	—	575-2 576A-576B	4 3/4" (121mm)		
9875-F 9975-F	575	4 3/4" (121mm)		—	—	—	—	—	575-2 576A-576B	4 3/4" (121mm)		
	Strike	Application			Stile	Strike	Application		Stile			
					× 990	× 696/697			× 990	× 696/697		
9827 9927 Latch Retraction	299 (Top) 304L/248L-4 (Bottom)	Single door			3 11/16" (94mm)	3 5/8" (92mm)	260U (Top) 385A (Bottom)	Single door		3 11/16" (94mm)	3 5/8" (92mm)	
PL9827/PL9927 Pullman Latch	299 (Top) 304L/248L-4 (Bottom)	Two Vertical Rod Devices			3 11/16" (94mm)	3 5/8" (92mm)	260U (Top)	Two Vertical Rod Devices		3 11/16" (94mm)	3 5/8" (92mm)	
9827-F 9927-F	299 (Top) 304L (Bottom)	Vertical Rod w/Mortise Lock Device			4 3/4" (121mm)	4 3/4" (121mm)	385A (Bottom) 304L (Bottom)	Vertical Rod w/Mortise Lock Device		4 3/4" (121mm)	4 3/4" (121mm)	
9847 9947	338 (Top) 385A (Bottom)	Double			4 1/4" (108mm)	4 1/8" (105mm)	304L (Bottom)					
9847-F 9947-F	338 (Top) 385A (Bottom)						304L (Bottom)					
9848-F 9948-F												
9847WDC-F 9947WDC-F												

*Mullion information — refer to the General and Auxiliary catalog.

VON DUPRIN®

98/99 Strike Information

STRIKES FOR RIM DEVICES

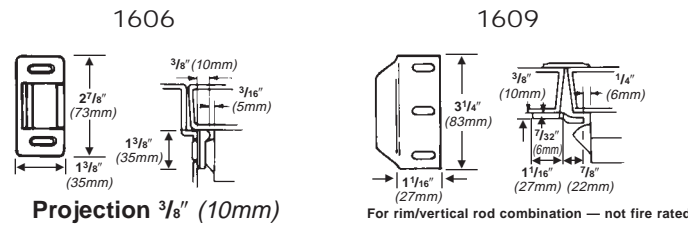
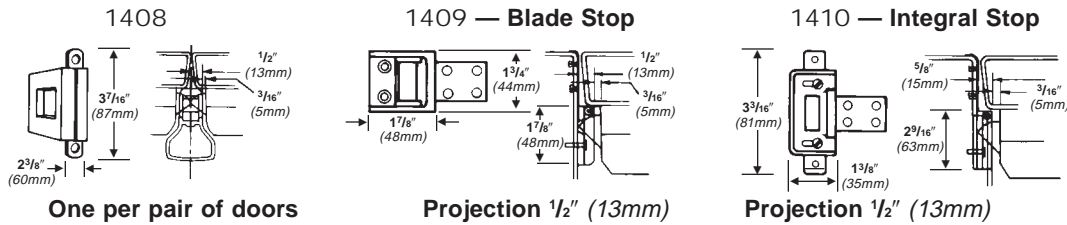
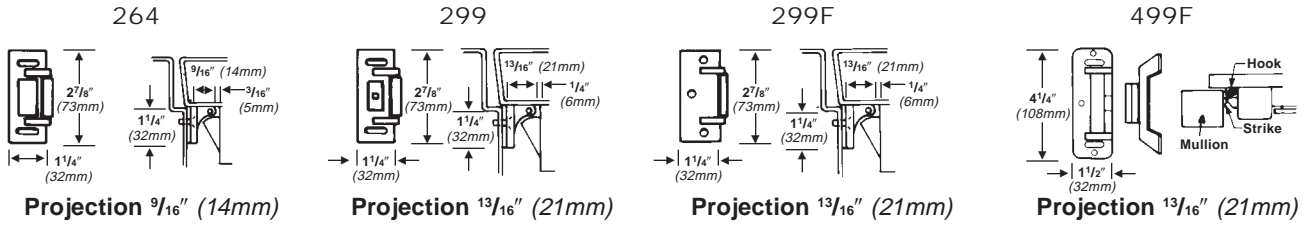

STRIKES FOR VERTICAL ROD DEVICES

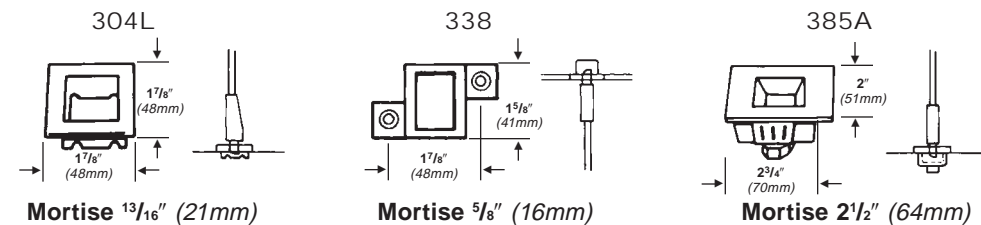
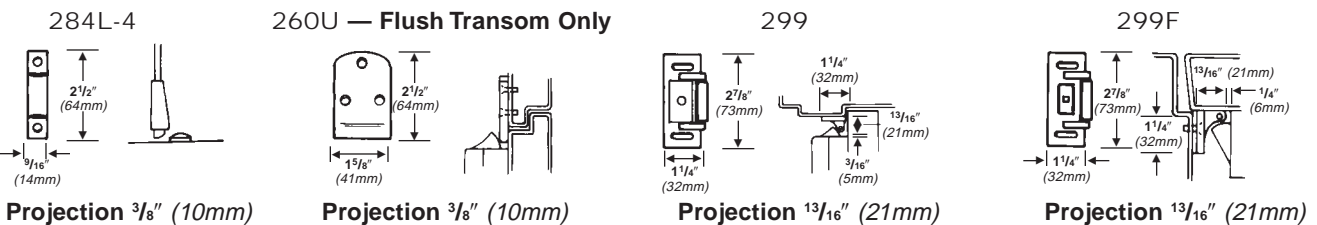

STRIKES FOR MORTISE LOCK DEVICES

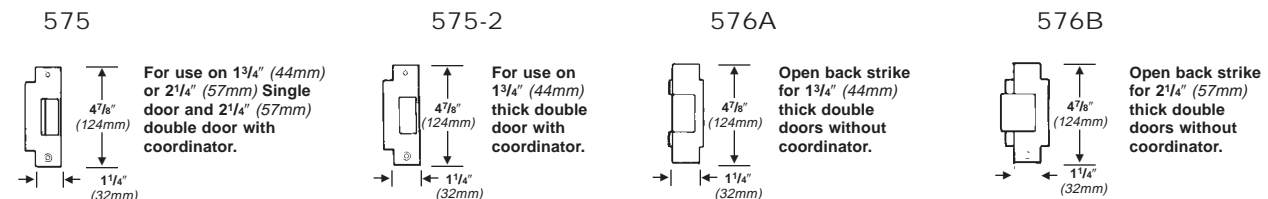

VON DUPRIN® 98/99 Options

ELECTRIC MORTISE LOCK DEVICE

The electric mortise lock device has all the versatility de

VON DUPRIN® 98/99 Options

ELECTRIC RIM DEVICE

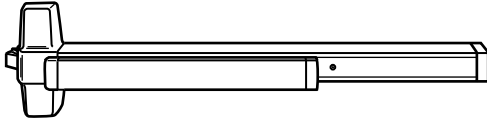

The electric rim device provides remote unlocking capabilities. A control station operator can flip a switch to lock or unlock the outside trim. The 24 VDC solenoid assembly contains a SPDT signal switch to monitor the outside trim (locked or unlocked).

The device is standard as fail safe (FS). When power is off, the trim is unlocked. The trim may then be relocked electrically by applying power. The device is field convertible for fail secure (FSE) applications.

The outside trim cylinder retracts the latchbolt for mechanical override.

Electrical Rating:

Each switch rated 0.3 Amp., 24 VDC.

To order, specify:

1. Use prefix "E", example E99TP.
2. Handing, LHR or RHR, see page 33.
3. Voltage, 24 VDC or 24 VAC/SO.
4. TP, K, or L functions only.

For typical electronic applications, see page 31.

ALK EXIT ALARM KIT

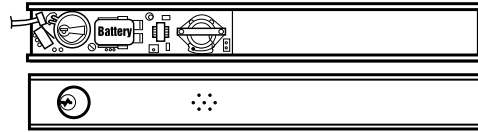

The ALK battery alarm kit is a simple yet effective way to monitor the use of an exit device. While still a means of egress, the unit contains an internal horn. When the touchbar is depressed, the horn sounds to provide an audible means of signaling that the opening has been violated.

The key switch uses a standard 1 1/4" (32mm) mortise cylinder. The unit operates on one standard 9-volt transistor battery. When the battery is weak the horn will emit an intermittent signal.

Alarm kits are available with a choice of two switch kits, S1 or S2. S1 monitors the touchpad and is furnished standard. S2 optional latchbolt monitoring is recommended for use with surface vertical rod exit devices. Specify ALK-S2.

The ALK is available in two styles, 33/99ALK, grooved cover and 35/98ALK, smooth cover.

The ALK includes "EMERGENCY EXIT ONLY. ALARM WILL SOUND" decal for application on door.

Minimum Door Sizes on ALK Applications

Device	3' (914mm) Length	4' (1219mm) Length
98/98-F/99/99-F	2'9" (838mm)	3'3" (991mm)
9875/9875-F/9975/9975-F	2'9" (838mm)	3'3" (991mm)
9827/9827-F/9927/9927-F	2'8" (813mm)	3'2" (966mm)
9847/9847-F/9947/9947-F	2'8" (813mm)	3'2" (966mm)
9848/9848-F/9948/9948-F	2'8" (813mm)	3'2" (966mm)

PS9 POWER SUPPLY

The PS9 is an AC power supply that provides 9 VDC power to operate the ALK alarm kit. The unit will power one or two alarm kits. Included is a 9-volt sealed battery that provides backup power in case of an AC power failure. PS9 must be ordered separately.

To order, specify:

1. 33/99ALK or 35/98ALK
2. Finish, see page 33.
3. × PS9, when required.

VON DUPRIN®

98/99 Options

SIGNAL SWITCH-SS



The SS feature is used to signal the unauthorized use of an opening. These devices are equipped with two internal SPDT switches. One switch monitors both the touch bar and the latch bolt assembly, making the latch bolt tamper resistant for positive security. An additional SPDT switch is connected to the 1¹/₄" (32mm) mortise cylinder (cylinder not furnished) for alarm bypass.

The device can be connected to a security console or may be used as a single door alarm when used with a horn and power supply. A continuous current electric transfer must be used for transferring power from the frame to the door.

The **SS mortise lock device** is furnished with both the signal switch device and the **SS7500** mortise lock.

The SS7500 mortise lock has the versatility and advantages of the 7500 lock with the addition of signalling functions to monitor latch bolt operation and the trim locking function.

This lock will normally be used with the SS9975 mortise lock device, which monitors egress. Other combinations are available, consult factory.

Touchpad trim is furnished US32D only and printed red "Emergency Exit Only, Push To Open & Sound Alarm".

Electrical Ratings:

Each switch rated 0.5 Amp., 24 VDC.

To order, specify:

1. Prefix SS, example SS99NL.
2. Handing, LHR or RHR.

LATCH BOLT MONITORING-LX



The LX feature is used to signal the use of an opening. These devices are equipped with one internal SPDT switch which monitors the latch bolt.

The device can be connected to a security console or may be used as a single door alarm when used with a horn and power supply. A continuous current electric transfer must be used for transferring power from the frame to the door.

Note: The LX switch option should not be used to control a load, but as a signalling switch (5.0 amps. maximum).

Electrical Ratings:

0.5 Amp., 24 VDC

To order, specify:

1. Use prefix LX, example LX99EO.

REQUEST TO EXIT-RX



The RX (Request to Exit) feature is used to signal the use of an opening. These devices are equipped with one internal SPDT switch which monitors the touch bar.

The device can be connected to a security console or may be used as a single door alarm when used with a horn and power supply. A continuous current electric transfer must be used for transferring power from the frame to the door.

Note: The RX switch option should not be used to control a load, but as a signalling switch (5.0 amps. maximum). The RX device was designed for use with the DE5101 Delayed Exit Control System; other applications should have approval by the local authority having jurisdiction.

Electrical Ratings:

0.5 Amp., 24 VDC

To order, specify:

1. Use prefix RX, example RX99EO.

VON DUPRIN® 98/99 Options

THE CHEXIT®

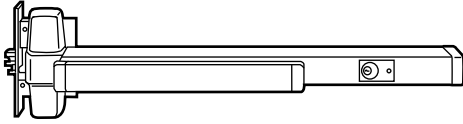

Chexit controlled exit device for use on Accident Hazard or Fire Exit hardware applications.

All controls, auxiliary locking, local alarm, and remote signalling are self-contained in the Chexit, providing safe, secure, easy to install, and simple to operate door control and exit hardware.

This new concept in delayed exit systems combines life safety with the needs of security and meets all requirements of NFPA 101 for "Special Locking Arrangement."

Designed for use on delayed exit applications, the Chexit system is ideal for highly controlled areas such as computer rooms and research labs because the Chexit can function as a "man trap" in controlling and monitoring the usage of an opening.

Refer to Von Duprin Chexit catalog for complete specification information.

PNEUMATIC CONTROLLED EXIT DEVICES

— PN



The PN feature provides remote unlocking or latch bolt retraction in hazardous areas where electrically operated devices would not be permitted. The pneumatic solenoid will retract the latch bolt for momentary or prolonged periods. PN exit devices are particularly suited for use with automatic door operators.

The PN feature includes a special actuating linkage that gives building owners the option of mechanically or pneumatically dogging the exit device. (Dogging the device, whether mechanically or pneumatically, makes the device function as a push/pull unit and reduces the wear on its moving parts.)

When activated pneumatically, the latch bolt(s) of the exit device retract in $\frac{1}{2}$ to $1\frac{1}{2}$ seconds. This pneumatic operation uses air pressure ranging from 50 to 100 pounds per square inch.

This product will function only when it is part of a pneumatic system (air compressor, air lines, pneumatic switch, etc.).

To order, specify:

1. Prefix PN, example PN99NL.

BRAILLE AND EMBOSSED TOUCHPADS



Embossed touchpad with the message "CAUTION STAIRWELL" in braille and raised letters provides assistance to person with impaired vision. Letters are $\frac{1}{2}$ " (13mm) high and braille is #2, raised height is $\frac{3}{32}$ " (2mm). Other messages are available on special order, limited to 20 characters per line.

DOUBLE CYLINDER



Double cylinder features an inside key cylinder which locks or unlocks the outside trim and an outside key cylinder which retracts the latch bolt only. Available on rim or mortise lock device.

Rim requires two rim type cylinders, mortise device requires 1 rim cylinder and 1 mortise cylinder.

Available trims are: 990TP, 991K, 992L, 696TP or 697TP.

To order, specify:

1. Suffix-2 with device/trim number, example 99TP-2.
2. Handing, LHR or RHR, see page 34.

VON DUPRIN® 98/99 Accessories

VERTICAL ROD AND LATCH GUARD — RG-27

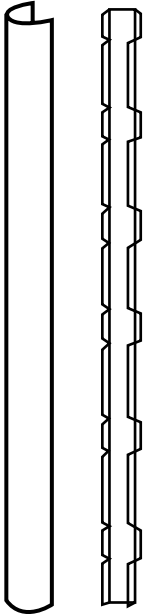

Series RG-27 Vertical Rod and Latch Guards protect the bottom rod of an exit device from damaging impacts obtained from carts or gurneys passing through doors. If these rods become damaged, the exit device will not function as intended and can jeopardize the ability to exit safely during an emergency.

In addition to protecting the vertical rod, the guard provides a smooth, unobstructed surface so the door can be pushed open easily with the bumpers of a wheelchair. The latch guard portion fits 10" high from bottom edge of door and features a 45° ramp on standard latch guard and a continuous ramp on full width or extended latch guard.

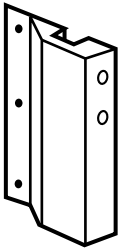

Models

- RG-27** — Rod and latch guard.
- RG-27-3** — 3' (914mm) Extended rod and latch guard.
- RG-27-4** — 4' (1219mm) Extended rod and latch guard.
- RGO** — Rod guard only.

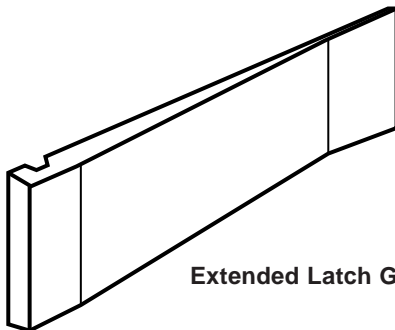

Extended Latch Guard

- LGO** — Latch guard only.
- LGO-3** — 3' (914mm) Extended latch guard only.
- LGO-4** — 4' (1219mm) Extended latch guard only.

To order, specify:

1. Model number

ELECTRICAL POWER TRANSFER

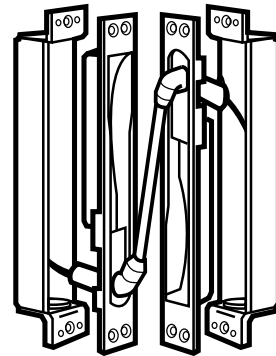

The EPT provides a means to transfer power from the frame to the door stile in EL98/99 1³/₄" (44mm) thick door applications: up to 5" (127mm) butt hinges — 180° opening, 3/4" (19mm) offset privots — 180° opening, 5¹/₂" (140mm) butt hinges — 130° opening, and 6" (152mm) butt hinges — 110° opening. When the door is closed, the unit is concealed and tamper resistant.

Two models are available, EPT-2 (two 18 gauge wires) and EPT-10 (ten 24 gauge wires).

UL Fire Listed for use with listed rim, mortise, and vertical rod fire devices with electric latch retraction feature.

Pneumatic Control — PNT-1 is available for pneumatic latch retraction exit devices. Appearance and dimensions are identical to EPT models.

Dimensions

Housing	9" × 1 ¹ / ₄ " × 1 ¹ / ₂ " (229mm × 32mm × 38mm)
Conductors	Two 18 AWG., ten 24 AWG or one 1 ⁵ / ₃₂ " (29mm) Tube UL Approved
Rating	EPT-2, 2 Amps. at 24 VDC, 16 Amps. maximum surge EPT-10, 1 Amp. at 24 VDC

To order, specify:

1. EPT-2 or EPT-10.
2. Finish, SP28 (sprayed aluminum) or SP313 (sprayed duranodic).

VON DUPRIN® 98/99 Accessories

POWER SUPPLIES

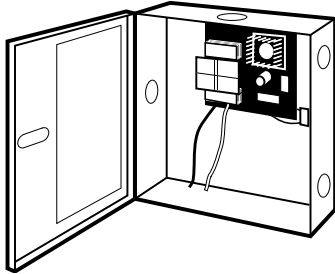

Standard
UL Listed
Class 2, Power Supply
UL1012
UL1310

The series PS861 power supply is designed for electric locking or monitoring on single or double door applications. The output power is field selectable for either 24 VDC @ 1 ampere or 12 VDC @ 2 ampere. Standard input 120 VAC @ 0.6 ampere and 240 VAC @ 0.3 ampere available. Terminal block will accept up to 14 gauge stranded wire.

Enclosure is 10" × 10" × 4" (254mm × 254mm × 102mm) gray with 1 hinged cover and constructed of heavy 19 gauge steel. Six 1/2" (13mm) knockout holes are provided for conduit connection.

Options include keylock cover and sealed lead acid battery pack. The pair of batteries will provide back-up power for three hours at full load or seven hours at half load. Batteries will automatically recharge when failed power is restored.

FOUR MODELS:

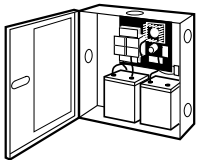

*With keylock
and batteries*

- | | |
|---------|------------------------------------|
| PS861 | Standard supply |
| PS861K | Standard supply with keylock cover |
| PS861B | Battery backup |
| PS861BK | Battery backup and keylock cover |

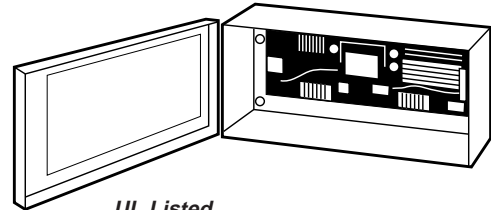

UL Listed
Class 2, Power Supply
UL1012
UL1310

The series PS871 power supply is designed to operate electric locking or monitoring exit devices, except EL (electric latch retraction). The regulated output power is field selectable for either 24 VDC @ 2 ampere or 12 VDC @ 4 ampere. Standard input 120 VAC @ 1.0 ampere or 240 VAC @ 0.5 ampere is available.

Enclosure is 5 7/8" × 12 1/2" wide × 5" deep (149mm × 318mm × 127mm), gray with a hinged cover and constructed of heavy 19 gauge steel. Three 1/2" × 3/4" (13mm × 19mm) knockout holes are provided for conduit connection. Terminal block will accept up to 14 gauge wire.

Option — A 871-2 circuit card is available for field installation which converts the PS871 to the equivalent PS872 and will operate two EL devices.

The series PS872 power supply is designed to operate two EL (electric latch retraction) exit devices and replaces the MPB842. The regulated output power is 24 VDC @ 2 ampere. Standard input 120 VAC @ 1.0 ampere or 240 VAC @ 0.5 ampere is available.

Enclosure is 5 7/8" × 12 1/2" wide × 5" deep (149mm × 318mm × 127mm), gray with a hinged cover and constructed of heavy 19 gauge steel. Three 1/2" × 3/4" (13mm × 19mm) knockout holes are provided for conduit connection. Terminal block will accept up to 14 gauge wire.

Option — A 871-2 circuit card is available for field installation. 871-2 is a two zone controller card and when added to PS872 will operate four EL exit devices and replaces RBS884.

To Order, Specify:

1. Model number

VON DUPRIN® 98/99 Accessories

DUMMY PUSH BAR



The 330 grooved and 350 smooth dummy push bars are designed as a companion unit for all 98 or 99 devices. The touch bar is rigid and non-functioning. A push/pull operation can be accomplished by using 990DT, 696DT, or 697DT trim.

To order, specify:

1. 330 or 350.
2. Size, 3' or 4' (914mm or 1219mm).
3. Finish, see page 35.

CYLINDER DOGGING — CD

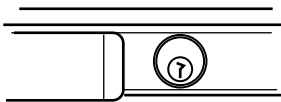

Cylinder dogging is available on all 98/99 devices to replace the standard hex key dogging. Furnished, not installed. Unit requires a standard 1 1/4" (32mm) mortise cylinder.

To order, specify:

1. Prefix CD, example CD99NL.

CYLINDER DOGGING KIT — CDK

For field conversion, a cylinder dogging conversion kit is available. **Order: 33/99CDK or 35/98CDK**, specify finish.

HEX KEY DOGGING KIT — HDK

For field conversion, a hex key dogging conversion kit is available. **Order: 33/99HDK or 35/98HDK**, specify finish.

GLASS BEAD KIT

Glass bead conversion kits are available for all 99 Series devices for use on doors with raised glass beads. Each kit consists of 1/4" (6mm) shim sets.

To order, specify:

1. 99GBK.
2. Device type (rim, mortise, surface vertical and concealed vertical rod.)
3. Wood door, when used with concealed vertical.

COVER PLATES KIT — 997 KIT

For 99 rim device, kit contains inside and outside plates for hinge stile cutouts, an inside plate for the lock stile, and necessary screws. Plates are designed to cover cutouts required by most existing exit device installations. Specify finish.

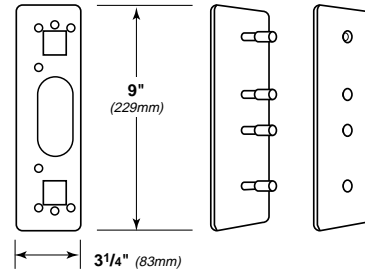

CYLINDERS

Cylinders are not furnished with device or trim and must be specified when ordering. Rim, surface vertical rod, and concealed vertical rod exit devices use rim type cylinders. Mortise lock exit devices and series 370 controls use mortise type cylinders.

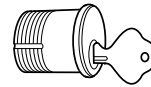

Mortise — 3215 (Schlage B502-191 cam)

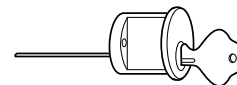
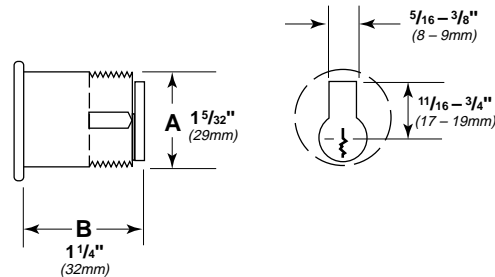

Rim — 3216

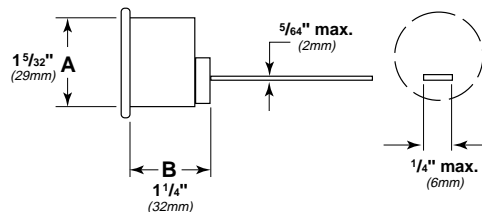

VON DUPRIN®

98/99 Additional Information

ELECTRICAL APPLICATIONS

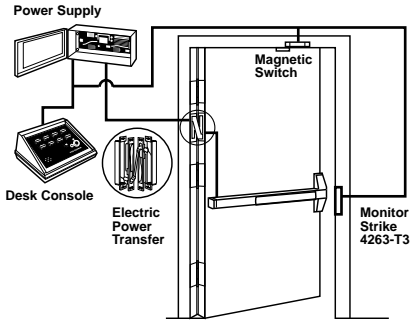

EL – Electric Latch Retraction

This system provides both monitoring of the door security as well as remote latch retraction for push pull operation.

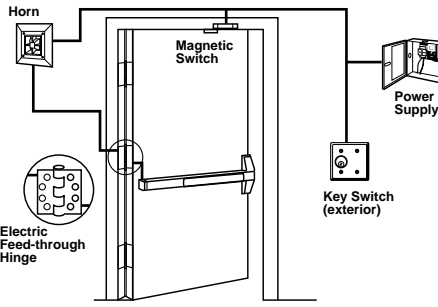

SS – Signal Switch

Unauthorized use of this opening will activate the local horn. The key switch permits inhibiting this system for authorized entry.

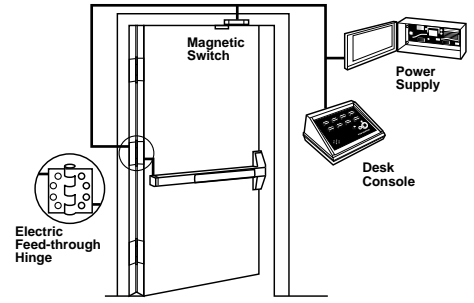

E9975 – Electric Mortise Lock Device

— Adaptable for openings where continuous latching is required while the trim may be electrically locked or unlocked from a remote location — stairwells, exterior doors, etc.

POPULAR DOUBLE DOOR APPLICATIONS

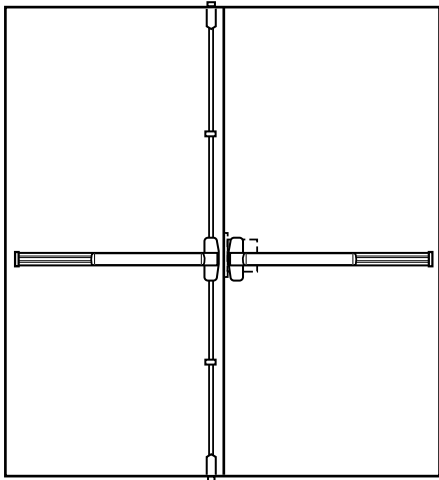

Mortise lock and surface mounted vertical rod device combination — same direction

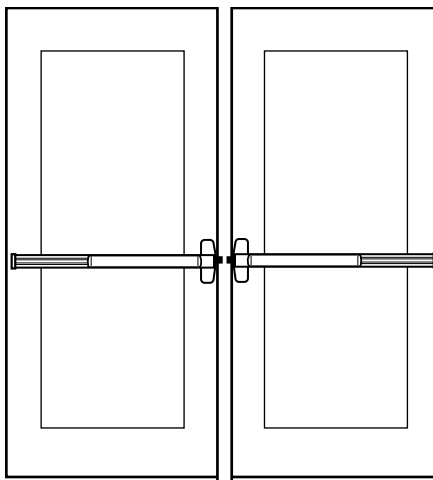

Two rim devices with mullion — same direction

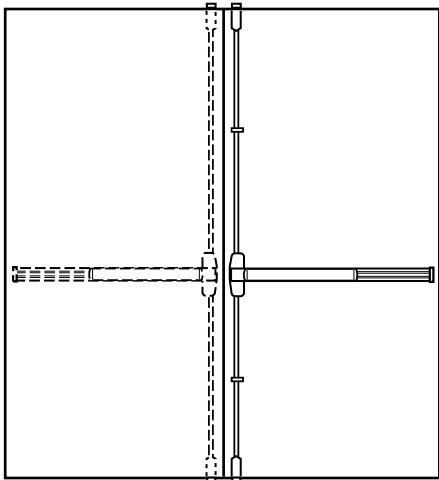

Two vertical rods — double egress

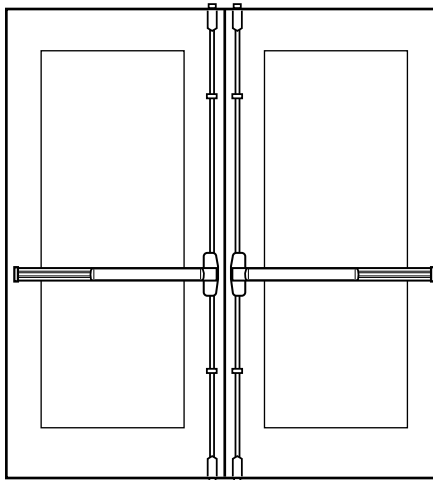

Two surface mounted vertical rod devices — same direction (do not use with overlapping astragal)

VON DUPRIN®

98/99 Additional Information

ANSI GRADE, TYPE & FUNCTION

Function	Grade 1 – Type 1	Grade 1 – Type 2	Grade 1 – Type 3	Grade 1 – Type 7	Grade 1 – Type 8	Grade 1 – Type 9
01	98EO, 98EO-F 99EO, 99EO-F	9827EO, 9827EO-F 9927EO, 9927EO-F	9875EO, 9875EO-F 9975EO, 9975EO-F	9847WDC-EO 9947WDC-EO	9847EO, 9848EO-F 9947EO, 9948EO-F	9857EO, 9857EO-F 9957EO, 9957EO-F
02	98DT 99DT	9827DT 9927DT	9875DT 9975DT	9847WDC-DT 9947WDC-DT	9848DT 9948DT	9857DT 9957DT
03	98NL, 98NL-F 99NL, 99NL-F	9827NL, 9827NL-F 9927NL, 9927NL-F	9875NL, 9875NL-F 9975NL, 9975NL-F	9847WDC-NL 9947WDC-NL	9847NL, 9848NL-F 9947NL, 9948NL-F	9857NL, 9857NL-F 9957NL, 9957NL-F
05	98TP, 98TP-F 99TP, 99TP-F	9827TP, 9827TP-F 9927TP, 9927TP-F	9875TP, 9875TP-F 9975TP, 9975TP-F	9847WDC-TP 9947WDC-TP	9847TP, 9848TP-F 9947TP, 9948TP-F	9857TP, 9857TP-F 9957TP, 9957TP-F
07	98TP-2, 98TP-F-2 99TP-2, 99TP-F-2	—	—	—	—	—
08	98K, 98K-F 99K, 99K-F	9827K, 9827K-F 9927K, 9927K-F	9875K, 9875K-F 9975K, 9975K-F	9847WDC-K 9947WDC-K	9847K, 9848K-F 9947K, 9948K-F	9857K, 9857K-F 9957K, 9957K-F
	98L, 98L-F 99L, 99L-F	9827L, 9827L-F 9927L, 9927L-F	9875L, 9875L-F 9975L, 9975L-F	9847WDC-L 9947WDC-L	9847L, 9848L-F 9947L, 9948L-F	9857L, 9857L-F 9957L, 9957L-F
10	98K-2, 98K-F-2 99K-2, 99K-F-2	—	—	—	—	—
	98L-2, 98L-F-2 99L-2, 99L-F-2	—	—	—	—	—
11-12	—	9827TL, 9827TL-F 9927TL, 9927TL-F	—	9847WDC-TL & TL-F 9947WDC-TL & TL-F	9847TL, 9848TL-F 9947TL, 9948TL-F	—

UL LISTED — FIRE EXIT HARDWARE LABEL/OPENING SIZE

Exit Device	Single Door	Double Doors			Double Egress
		With Mullion	Same Direction Vert./Vert.*	Same Direction Vert./Mortise*	
98-F 99-F	3 Hour 4' × 8'	3 Hour 8' × 8'	—	—	—
9875-F 9975-F	3 Hour 4' × 10'	—	—	3 Hour 8' × 10'	—
9827-F 9927-F	—	—	90 Min.*** 8' × 8'	3 Hour 8' × 8'	3 Hour 8' × 8'
9827LBR-F** 9927LBR-F	—	—	90 Min. 8' × 8'	—	3 Hour 8' × 8'
9847-F 9947-F	—	—	90 Min. 8' × 8'	3 Hour 8' × 8'	3 Hour 8' × 8'
9847LBR-F 9947LBR-F	—	—	90 Min. 8' × 8'	—	3 Hour 8' × 8'
9848-F 9948-F	—	—	90 Min. 8' × 10'	3 Hour 8' × 10'	3 Hour 8' × 10'
9857-F 9957-F	3 Hour 4' × 8'	3 Hour 8' × 8'	—	—	—
9847WDC 9947WDC	—	—	90 Min. 8' × 9'3"	90 Min. 8' × 9'3"	—

*Currently, no door manufacturers offer a listing over 90 minutes, doors swinging same direction.

**Wood door applications, LBR option has a 20 minute label.

***Wood door applications, 45 minute label.

VON DUPRIN®

98/99 Additional Information

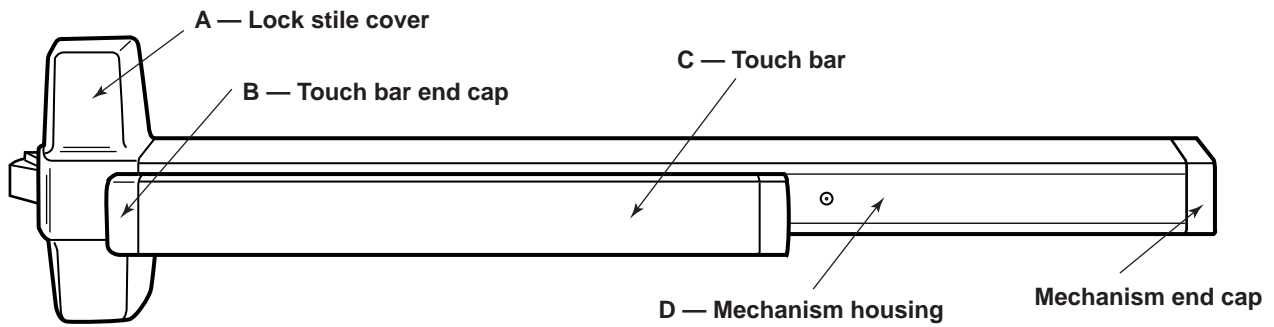

FINISHES

Color*	US Number	BHMA Number	A, B, E	C	D
Brass, Polished	US3	BHMA605	Plated	Brass, Polished US3, BHMA605	Buffed Anodized
Brass, Satin	US4	BHMA606	Plated	Brass, Dull US4, BHMA606	Anodized
Bronze, Satin	US10	BHMA612	Plated/Anodized Bronze, Dull US10, BHMA612		Anodized
Chrome, Polished	US26	BHMA625	Plated	Stainless Steel, Polished US32, BHMA629	Buffed Anodized
Chrome, Satin	US26D	BHMA626	Plated	Stainless Steel, Satin US32D, BHMA630	Anodized
Stainless Steel, Satin	US32D	BHMA630	Stainless Steel	Stainless Steel, Satin US32D, BHMA630	Anodized
Aluminum, Anodized	US28	BHMA628	Painted	Stainless Steel, Satin US32D, BHMA630	Anodized
Duranodic Dark Bronze	313	—	Painted	Wood grain vinyl**	Anodized

Touch Bar Options — Knurled — Black vinyl — Walnut grain vinyl — Embossed “Push”, brass, bronze or stainless steel

*US32D Finish — available on Series 98, consult factory.

**US10B available, consult factory.

VON DUPRIN®

98/99 Additional Information

NOMENCLATURE

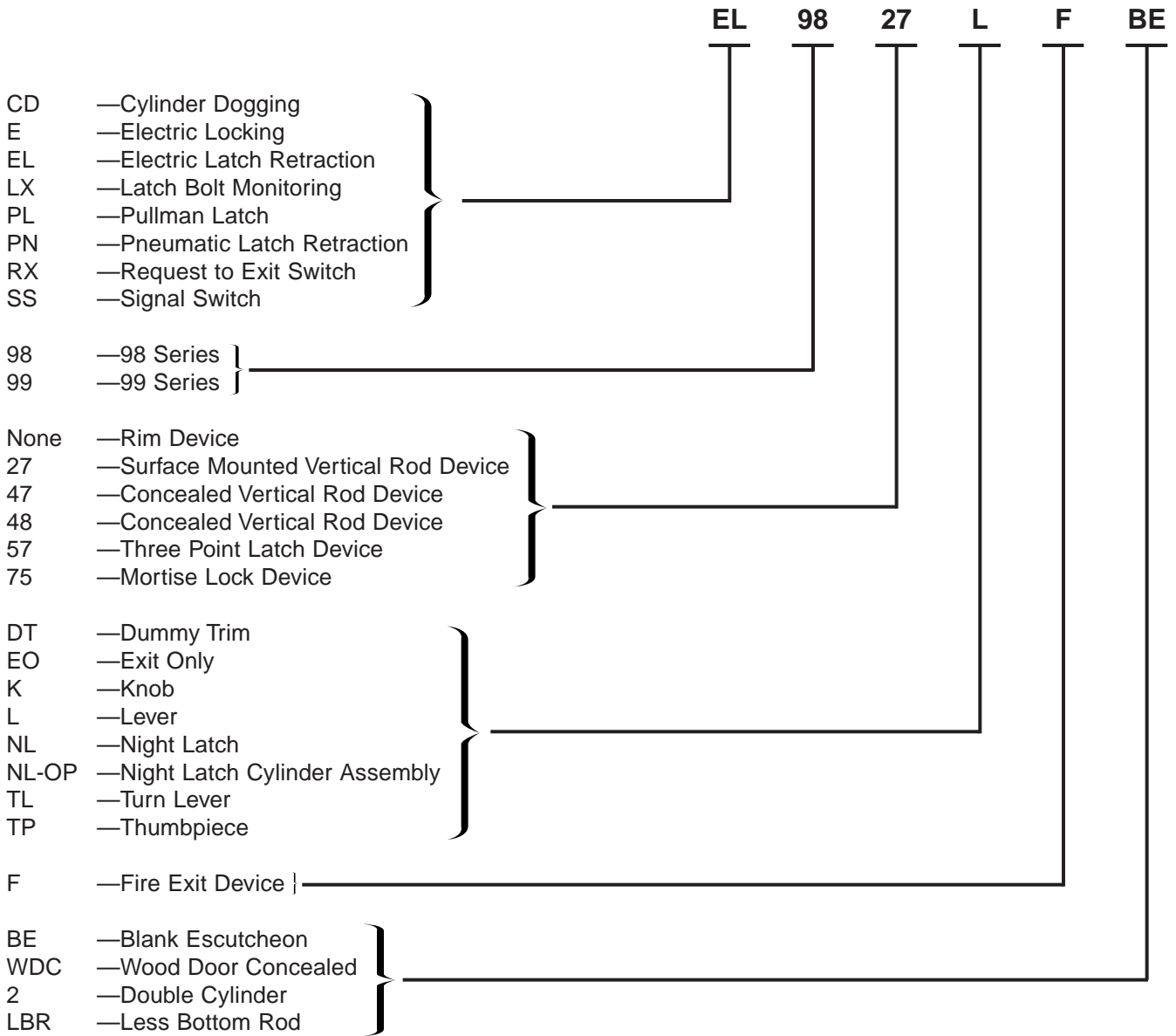

VON DUPRIN®

98/99 Additional Information

HOW-TO-ORDER INFORMATION

Rim, mortise lock devices, specify:

- Exit device model number with trim selection.
Examples: 99EO (exit device with no outside trim). 99TP (includes standard 990TP trim). 99TP × 696TP (includes optional 696TP trim).
- Size 4' (1219mm) for door sizes 3'1" (940mm) to 4' (1219mm).
Size 3' (914mm) for door sizes 2'6" (792mm) to 3' (914mm) is shipped standard.
- Door thickness if other than 1³/₄" (44mm).
- Door and frame material if other than hollow metal.
- Finish, see page 34.
- Handing required on "SS", "E", "CD/CX", "98/99-2". Specify LHR or RHR.
- "SNB" when using sex nuts and bolts.

Vertical rod, three point latching devices, specify:

- Exit device model number with trim selection.
Examples: 9927EO (exit device with no outside trim). 9927TP (includes standard 990TP trim). 9927TP × 696TP (includes optional 696TP trim).
- Size 4' (1219mm) for door sizes 3'1" (940mm) to 4' (1219mm).
Size 3' (914mm) for door sizes 2'6" (792mm) to 3' (914mm) is shipped standard.
- Door thickness if other than 1³/₄" (44mm).
- Door height if greater than 7' (2134mm), extension rods must be ordered.
- Door and frame material if other than hollow metal.
- Finish, see page 34.
- Handing required on "SS" and "CD/CX". Specify LHR or RHR.
- "SNB" when using sex nuts and bolts.

Pullman latches are optional for 98/9927 devices. Latch bolts remain extended at all times. Specify, "Pullman Latch" when required.

DIMENSIONS

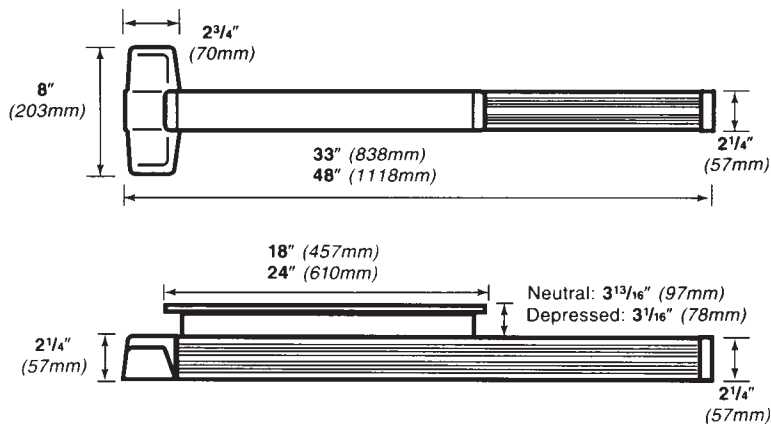

HANDING

